

■ SPECIFICATIONS

Product Composition	Wireless transmitter ...1, Receiver ...1, Lavalier microphone ...1
Frequency Range	694 - 806MHz(*1), UHF
Channel Selectable	4 Channels
Tunable Frequencies	25kHz Steps
Tone Frequency	32.768kHz
Total Harmonic Distortion	<1% @ 1kHz
Function	IR sync, Channel scan, Battery indicator
Accessory	Screw driver ...1
	Lavalier Microphone ...1

Wireless transmitter

Microphone Element	Back electret condenser; Omni-directional
RF Carrier Power	10mW
Audio Frequency Response	50 - 15000 Hz
Maximum Input Level	-6dBV (maximum), mic gain 0dB
Oscillator	PLL synthesizer
Battery	1 AA size alkaline battery, 1.5 V
Battery Life	Approx. 10 hours
Indication	Battery status LED, 7 segments LED
Finish	Resin, coating
Dimensions	62(W) x 100(H) x 25(D) mm (with clip)
Weight	approx. 85 g (with battery)

Wireless receiver

Power Source	AC mains (supplied AC-DC adapter must be used)
Sensitivity	10uV at 45dBA S/N
Squelch System	Tone SQ, Carrier SQ, Noise SQ
Audio Frequency Response	50 - 15000Hz
Audio Output Level (Maximum)	Balanced (XLR socket) : -20dBu Un-balanced (1/4" jack socket) : 10dBu
Power Consumption	11-18 VDC 300mA
Dimensions	215(W) x 39(H) x 102(D) mm (excluding antenna and BNC)
Weight	480g

(\*1)

Band	Frequency
A	694 - 703 MHz, UHF
B	748 - 758 MHz, UHF
C	803 - 806 MHz, UHF



# Single Wireless set

WS-430-AS WA1D00  
 WS-430-AS EB7D00  
 WS-430-AS ECBD00

## ■ APPEARANCE

### Wireless Transmitter

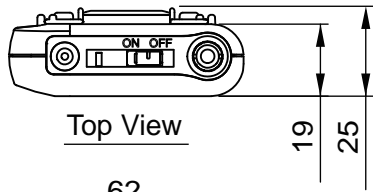

Top View

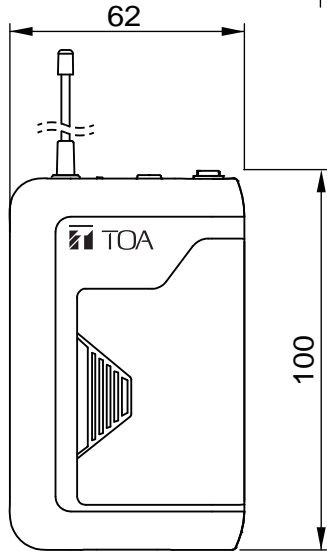

Front View

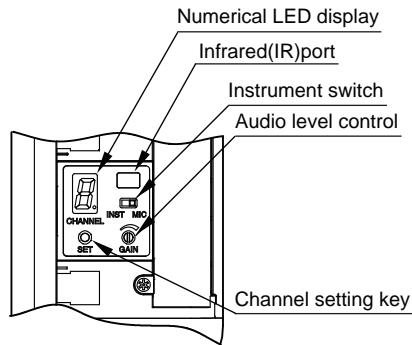

Inside of a battery cover

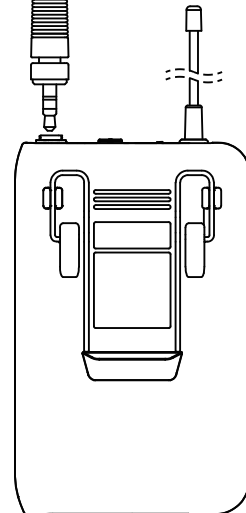
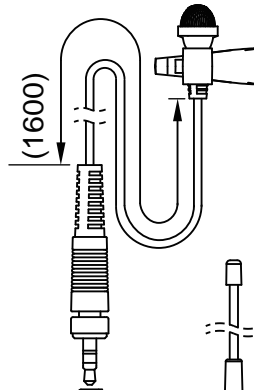

Rear View

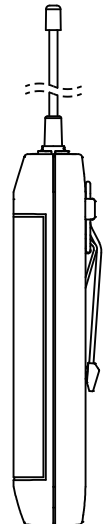

Side View

### Wireless Receiver

Rear View

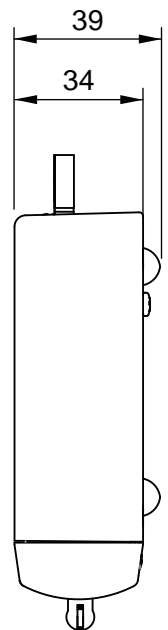
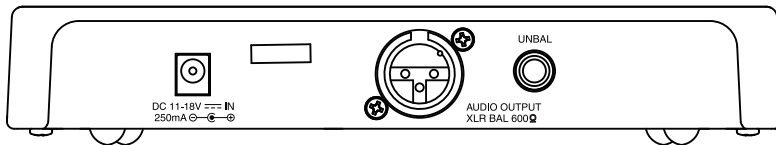

Side View

Top View



Front View

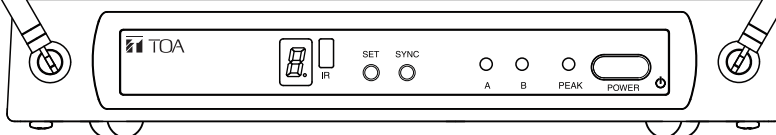

UNIT: mm