



OPERATING INSTRUCTIONS

DA-Z250D AS

DUAL POWER AMPLIFIER

Please follow the instructions carefully in this manual to obtain optimum results.
We also recommend that you keep this manual handy for future reference.

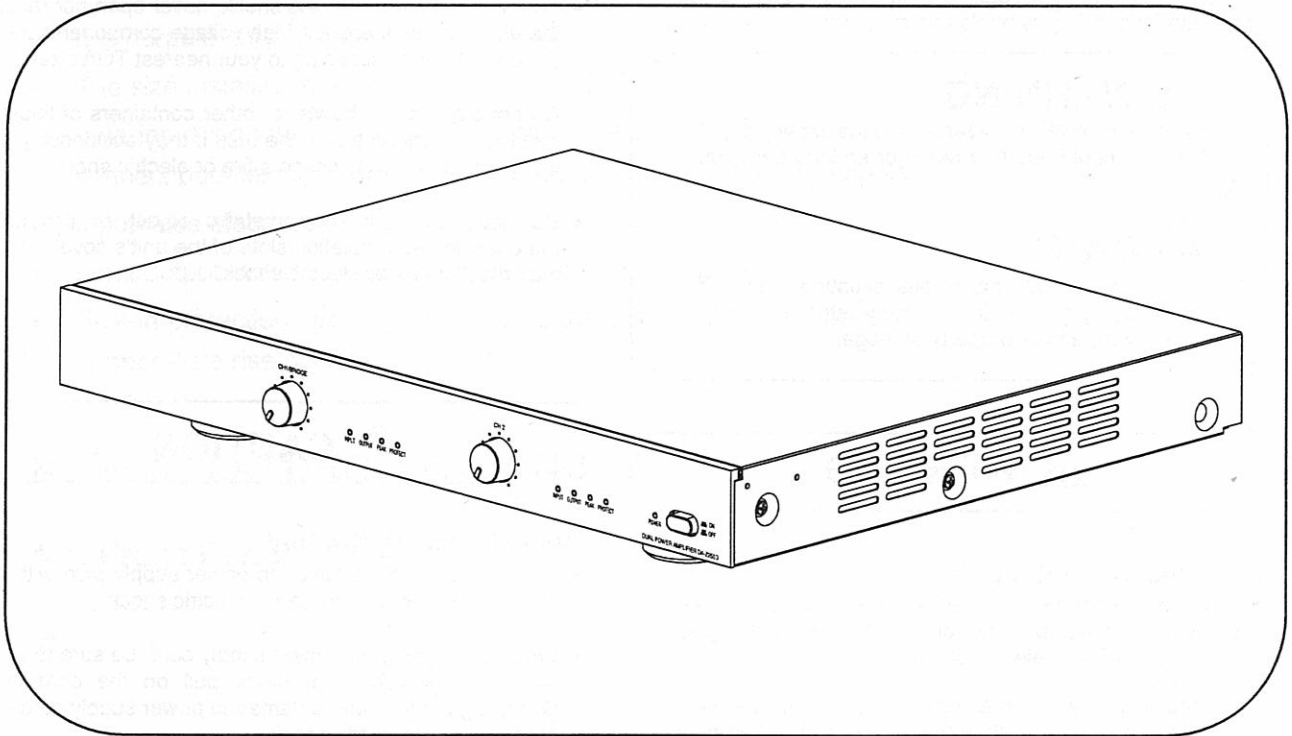

Table of Content

1. SAFETY INSTRUCTIONS	2
2. GENERAL DESCRIPTION	3
3. FEATURES	3
4. PARTS AND FUNCTIONS	3
4.1. FRONT PANEL	3
4.2. REAR PANEL	3
5. INSTALLATION	4
6. CONNECTIONS	5
6.1. Input Connections	5
6.2. Switch Adjustment and connections to the speaker	5
7. ADJUSTMENT OF VOLUME CONTROL	6
8. PROTECTION OPERATING LIST	6
9. BLOCK DIAGRAM	6
10. DIMENSIONS	7
11. SPECIFICATIONS	8

1. SAFETY PRECAUTIONS

- Be sure to read the instructions in this section carefully before use.
- Make sure to observe the instructions in this manual as the conventions of safety symbols and messages regarded as very important precautions are included.
- We also recommend you keep this instruction manual handy for future reference.

Safety Symbol and Message Conventions

Safety symbols and messages described below are used in this manual to prevent bodily injury and property damage which could result from mishandling. Before operating your product, read this manual first so you are thoroughly aware of the potential safety hazards as well as understand the safety symbols and messages.

WARNING

Indicates a potentially hazardous situation which, if mishandled, could result in death or serious personal injury.

CAUTION

Indicates a potentially hazardous situation which, if mishandled, could result in moderate or minor personal injury, and/or property damage.

WARNING

When Installing the Unit

- Do not expose the unit to rain or an environment where it may be splashed by water or other liquids, as doing so may result in fire or electric shock.
- Use the unit only with the voltage specified on the unit. Using a voltage higher than that which is specified may result in fire or electric shock.
- Do not cut, kink, otherwise damage nor modify the power supply cord. In addition, avoid using the power cord in close proximity to heaters, and never place heavy objects –including the unit itself – on the power cord, as doing so may result in fire or electric shock.
- The terminals marked with the symbol  are hazardous live. The external wiring to these terminals requires installation by an instructed person.
- The socket-outlet shall be installed near the equipment and the plug (disconnecting device) shall be easily accessible.
- Be sure to replace the unit's terminal cover after connection completion. Because the voltage of up to 100V is applied to the high impedance speaker terminals, never touch these terminals to avoid electric shock.
- Be sure to ground to the safety ground (earth) terminal to avoid electric shock. Never ground to a gas pipe as a catastrophic disaster may result.

When the Unit is in Use

- Should the following irregularity be found during use, immediately switch off the power, disconnect the power supply plug from the AC outlet and contact your nearest TOA dealer. Make no further attempt to operate the unit in this condition as this may cause fire or electric shock.
 - If you detect smoke or a strange smell coming from the unit.
 - If water or any metallic object gets into the unit.
 - If the unit falls, or the unit case breaks.
 - If the power supply cord is damaged (exposure of the core, disconnection, etc.)
 - If it is malfunctioning (no tone sounds.)
- To prevent a fire or electric shock, never open nor remove the unit case as there are high voltage components inside the unit. Refer all servicing to your nearest TOA dealer.
- Do not place cups, bowls, or other containers of liquid or metallic objects on top of the unit. If they accidentally spill into the unit, this may cause a fire or electric shock.
- Do not insert nor drop metallic object or flammable materials in the ventilation slots of the unit's cover, as this may result in fire or electric shock.

CAUTION

When Installing the Unit

- Never plug in nor remove the power supply plug with wet hands, as doing so may cause electric shock.
- When unplugging the power supply cord, be sure to grasp the power supply plug, never pull on the cord itself. Operating the unit with a damaged power supply cord may cause a fire or electric shock.
- When moving the unit, be sure to remove its power supply cord from the wall outlet. Moving the unit with the power cord connected to the outlet may cause damage to the power cord, resulting in fire or electric shock. When removing the power cord, be sure to hold its plug to pull.
- Do not block the upper panel ventilation slots in the unit's cover. Doing so may cause heat to build up inside the unit and result in fire.
- Avoid installing the unit in humid or dusty locations, in locations exposed to the direct sunlight, near the heaters, or in locations generating sooty smoke or steam as doing otherwise may result in fire or electric shock.

When the Unit is in Use

- Do not place heavy objects on the unit as this may cause it to fall or break which may result in personal injury and/or property damage. In addition, the object itself may fall off and cause injury and/or damage.

2. GENERAL DESCRIPTION

Dual Power Amplifiers TOA DA-Z250D model is a highly efficient two channels power amplifier for the purposes of sound systems or music background in the multipurpose room / hall, restaurants, places of worship or rooms that require high-quality sound systems.

The DA-Z250D has a power output of 2 x 250 W (4Ω output) and 2 x 170 W (8Ω output). In addition, the DA-Z250D can have a bridge connection (channel 1 and channel 2 outputs connected to be one output), allowing it to be used as a monaural amplifier of 500 W (8Ω).

3. FEATURES

- It is durable, strong and highly efficient.
- The size installed in the rack is 1U (1U = 44.5mm)
- Two input signals (2 inputs CH) with the level control each CH1 and CH2, the input can connect parallel to become one input (input at CH1) and two outputs, CH1 and CH2.
- Inputs use electronically balanced.
- Input/output status use LED indicators for each channel.
- Built-in protection circuitry disconnects the output when a short circuit, overload, or unusual temperature rise occurs.

4. NUMENCLATURE AND FUNCTIONS

4.1. Front Panel

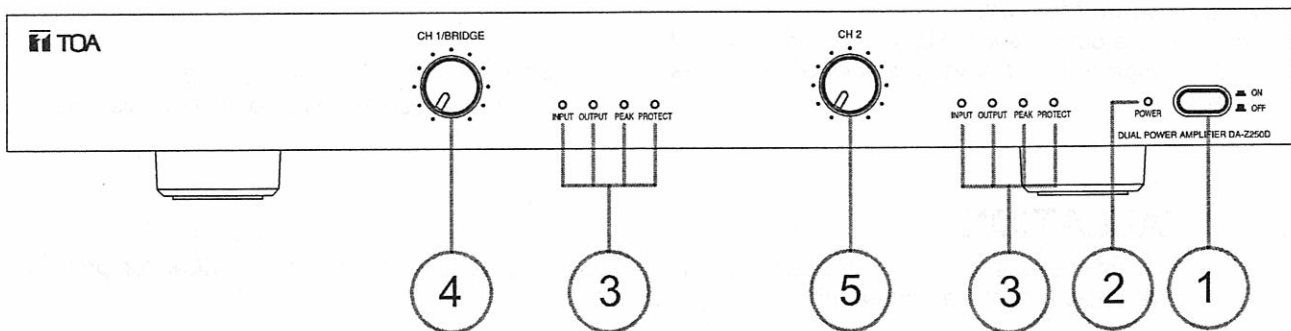

4.2. Rear Panel

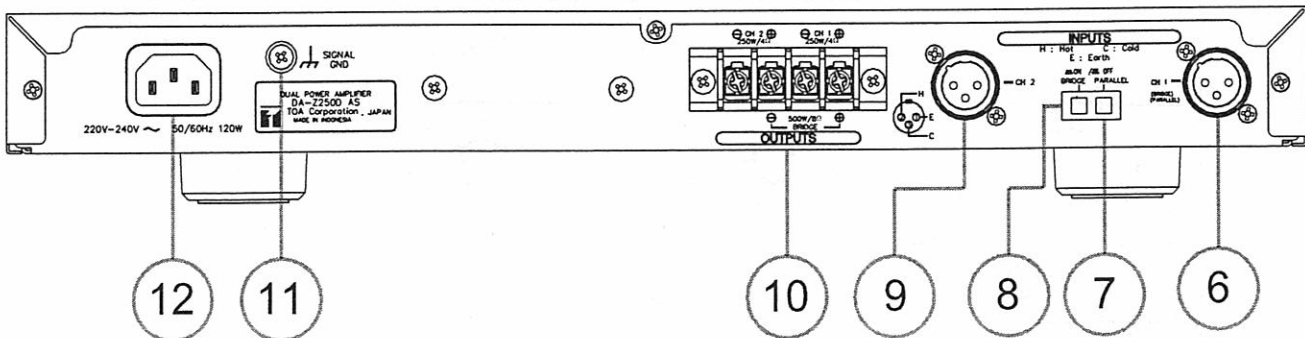

1. **Power Switch**
Power is switched on and off with each depression of this switch.
2. **Power Indicator**
Lights green when the power switch is ON.
3. **Indicator (Input, Output, Peak, Protect)**
Indicators from the left are as follows:
Input Indicator
Lights green when the input signal is about -20dB
Output Indicator
Lights yellow when an output signals around 1W during the load of 8Ω.
Peak Indicator
Lights red when the signal output is beyond the limit/output signal clips (if this indicator light, it means that the output signal has been distortion occurs).
Protect Indicator
Lights red when the protection circuitry is activated (see p.6: Protection Operation List).
4. **Volume Control for CH1/BRIDGE**
To adjust output level CH1 or during bridge connection. In this event, the CH2 volume control does not function.
5. **Volume Control for CH2**
To adjust the output level CH2. If SW parallel is ON or SW bridge is ON, the volume control CH2 does not work.

6. **Input CH1**
The input CH1 is an electronically balanced, the connector type uses XLR connector. Pin connectors of XLR are:
Pin 1: Earth, Pin 2: Hot, Pin 3: Cold.
7. **Parallel Switch**
At ON position, the input CH1 works, CH2 does not work. The output CH1 and CH2 with volume control function for each CH.
Note: Be sure power switch is in OFF position, during this parallel switch changes.
8. **Bridge Switch**
To connect bridge output CH1 and CH2. Please see p.5, section 6.2. The guidance to connect to the speaker.
9. **Input CH2**
The input CH2 is an electronically balanced, the connector type uses XLR connector. Pin connectors of XLR are:
Pin 1: Earth, Pin 2: Hot, Pin 3: Cold.
10. **Speaker Terminal**
Connect cables from each speaker to this terminal.
11. **Ground Terminal**
Hum noise may occur at the time connected with other equipment. Link this terminal to ground terminal of other equipment to reduce the hum noise.
12. **AC Inlet**
Connect the supplied power cord to this inlet.

5. INSTALLATION

The sides of the unit should be located more than 10cm of objects that may block airflow for prevent excessive heat inside the amplifier unit.

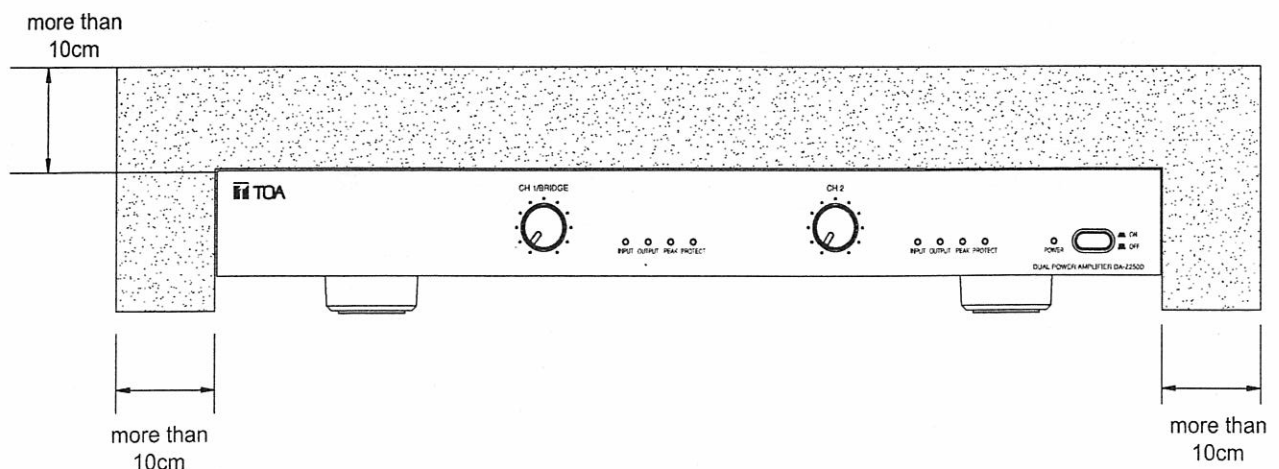

6. CONNECTIONS

6.1. Input Connections

- Input connection uses XLR connector and a shielded cable containing two cables.

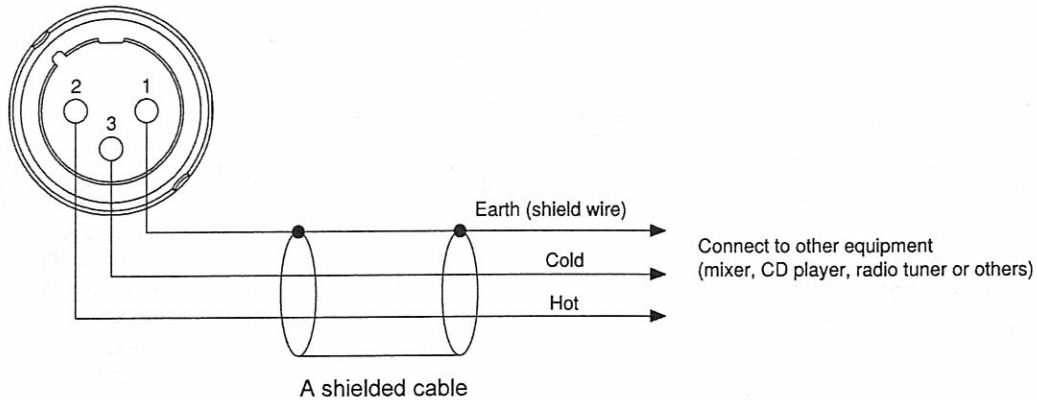

6.2. Switch Adjustment and connections to the speaker

6.2.1. [2 inputs – 2 outputs] (factory-preset)

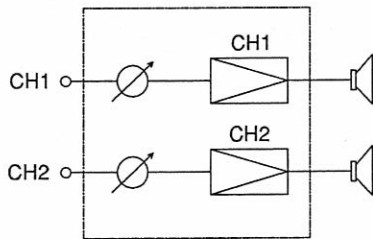

Switch	Setting
BRIDGE	OFF
Parallel Sw	OFF

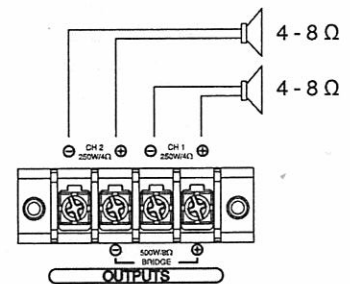

6.2.2. [1 input – 2 outputs]

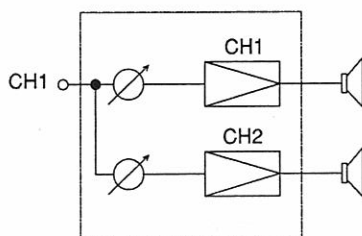

Switch	Setting
BRIDGE	OFF
Parallel Sw	ON

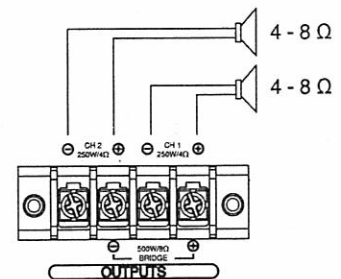

6.2.3. [1 input – 1 output]

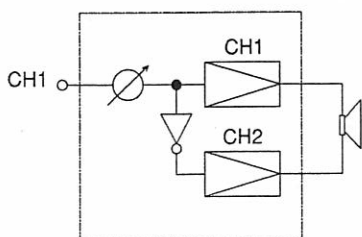

Switch	Setting
BRIDGE	ON
Parallel Sw	OFF

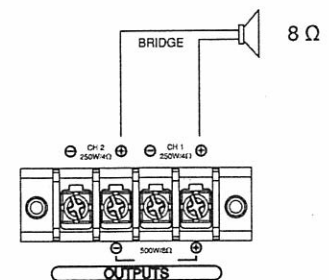

7. ADJUSTMENT OF VOLUME CONTROL

The volume control of each input can adjust output level. For music or speech, set the volume control before the peak indicator lights up, because at this stage sound will be distorted.

If the peak indicator lights or sound is distorted, decrease the sound level by rotating the volume control counter-clockwise until the peak indicator is off and the audible voice is in a good condition.

8. PROTECTIONS OPERATING LIST

Failure	Protection	Operation Indicator	Remedy	Recovery
Over-current due to speaker overload	Current limiter activated when impedance drops below the specified value	Peak Indicator lights.	Remove speaker load	Connecting a speaker load according to specifications automatically unit restores normal operation.
Short circuit	Current limiter activated. Load is disconnected	Protection indicator lights	Check appears and lines for short circuit	Turn off the power switch. Correct the load, and then switch off the power.
Temperature rise in heat sink / cooler (over 100°C)	Disconnect a speaker load	Protection indicator lights	Check the unit for correct ventilation and speaker overload	Operation automatically returns to normal when the temperature decreases.
Temperature rise inside the unit (over 80°C)	Built-in amplifier unit that caused the failure halted	Four indicators of the corresponding channel extinguish		
Abnormal DC voltage on speaker output	Disconnect a speaker load	Protection indicator lights	Contact the TOA dealer where the unit was purchased	

9. BLOCK DIAGRAM

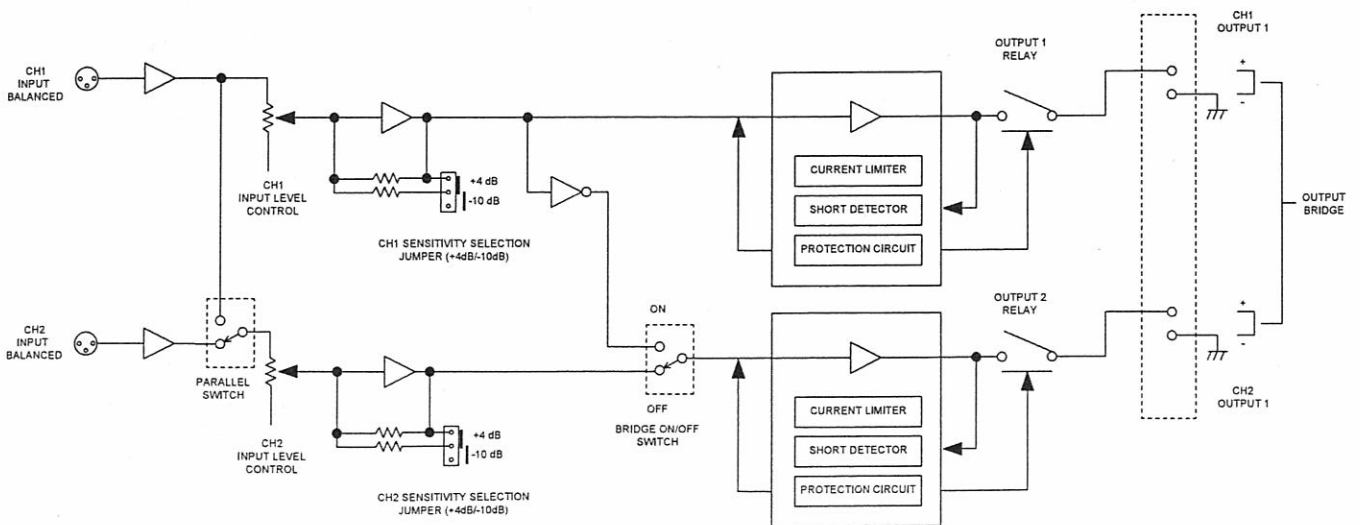

10. DIMENSION

Units: mm

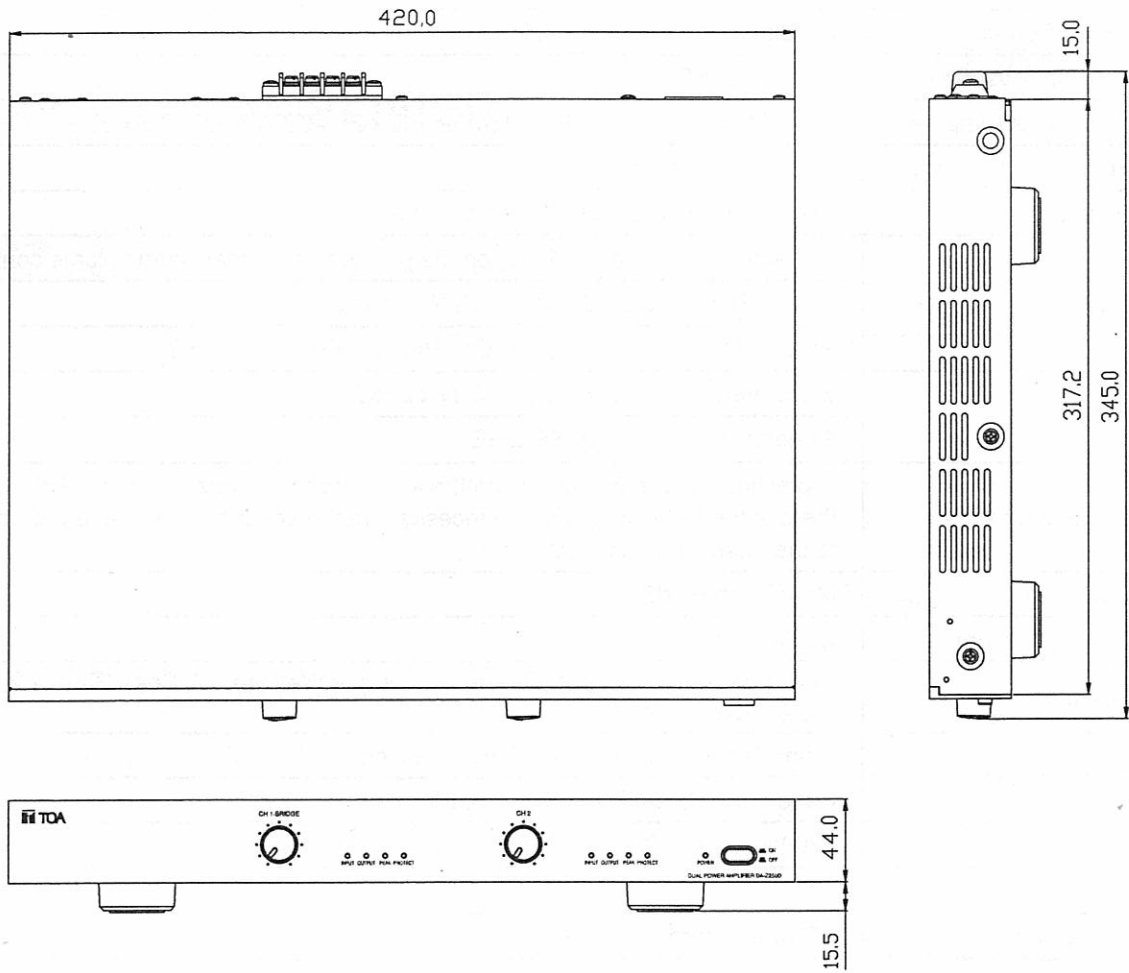

11. SPESIFICATIONS

Model	DA-Z250D AS
Power Source	AC 220 - 240 V AC, 50/60Hz
Amplifier System	Digital class D
Power Consumption	120 W (EN Standard), 620 W (rated 4Ω x 2), 400 W (rated 8Ω x 2)
Frequency Response	20 - 20,000 Hz, ±1 dB
Distortion	Less than 0.3% at 1kHz, 1/3 output rated
Inputs	2 channels, + 4 dBm* (1.23 V, on the position of the maximum volume control)
	10 kΩ, Electronically Balanced, XLR connector
	Parallel Switch ON/OFF CH1 (ON: Parallel, OFF: each CH)
Outputs	2 channels: 250 W x 2 (4Ω), 170 W x 2 (8Ω)
	1 channel: 500 W (8Ω), BRIDGE
Protection series	Protection for over-current when the load beyond the specifications, short-circuit, there is the DC voltage that unnecessary at the speaker output, and protection due to the increased excessive heat
S/N Ratio	More Than 80 dB
Cooling System	Cooling fan
Indicator	Power (Green) x 1, Input (Green) x 2, Output (Yellow) x 2, Peak (Red) x 2, Protect (Red) x 2
Final Process	Front Panel: Aluminum Hair Line, Etching Black
	Case : Steel Plate, Painting Black
Dimensions	420(W) x 59.5(H) x 345(D) mm
Weight	4.5 kg
Accessory	AC power cord 2 meters (1pce)

Note: *) 0 dBm = 0.775 V **) Specification is measured at the AC voltage of 230V.
The design and specifications are subject to change without notice for improvement.