

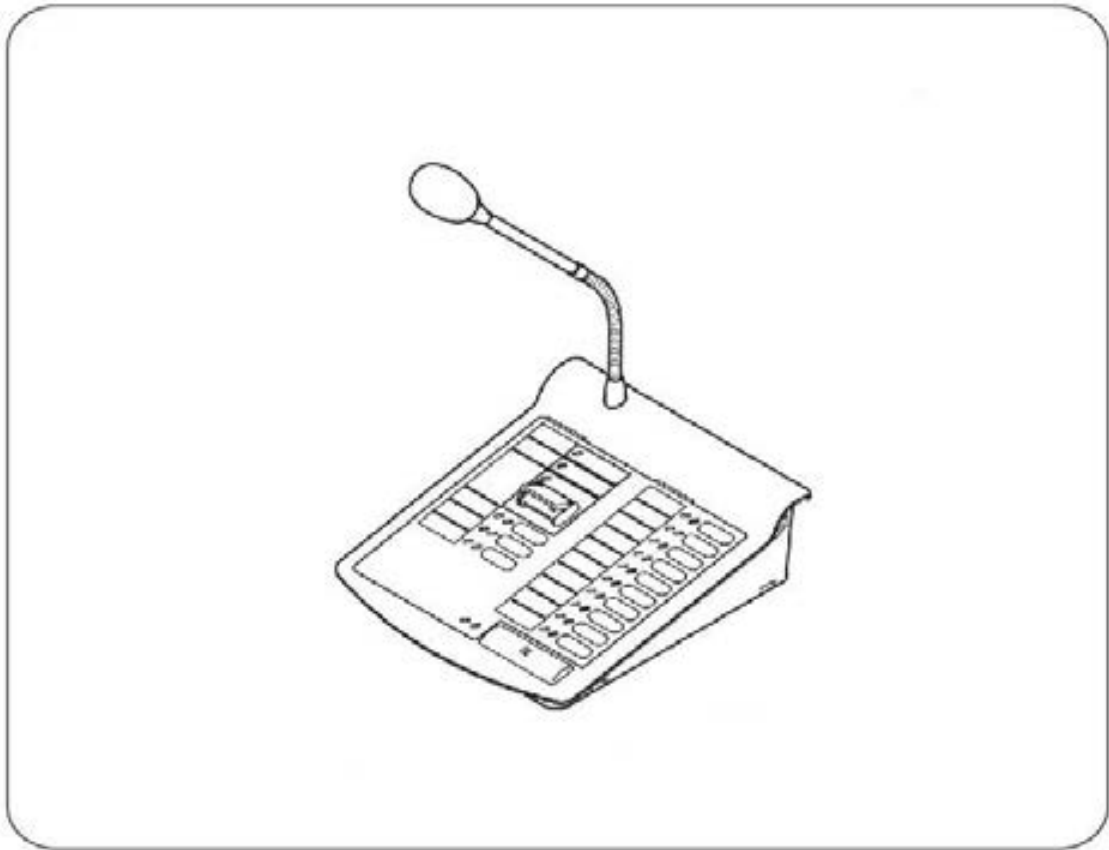

## INSTRUCTION MANUAL

**IP REMOTE MICROPHONE  
REMOTE MICROPHONE EXTENSION**

**VX-100RM  
RM-110VX**



Thank you very much for purchasing TOA VX-100RM product.  
Please read the instructions in this manual carefully, to ensure long-term, trouble-free operation of the system.

# TABLE OF CONTENTS

<b>TABLE OF CONTENTS .....</b>	<b>2</b>
<b>1 SAFETY PRECAUTIONS .....</b>	<b>3</b>
<b>2 PRODUCT INTRODUCTION.....</b>	<b>3</b>
2.1 Overview .....	3
2.2 Interface Description .....	4
<b>3 WIREING.....</b>	<b>8</b>
3.1 Wiring Diagram.....	8
3.2 Installation Instructions.....	9
<b>4 OPERATION INSTRUCTIONS.....</b>	<b>10</b>
4.1 VX-1000 Setting Software operating instructions .....	10
4.2 Zone broadcast .....	20
4.3 Pattern broadcast.....	22
4.4 Trigger control output task. ....	23
4.5 Monitoring Function.....	23
4.6 Dimension (Unit: mm) .....	24
<b>5 APPENDIX .....</b>	<b>25</b>
5.1 Specifications .....	25

# 1 SAFETY PRECAUTIONS

- Before installation or use, be sure to carefully read all the instructions in this section for correct and safe operation.
- Be sure to follow all the precautionary instructions in this section, which contain important warnings and/or cautions regarding safety.
- After reading, keep this manual handy for future reference.

## Safety Symbol and Message Conventions

Safety symbols and messages described below are used in this manual to prevent bodily injury and property damage which could result from mishandling. Before operating your product, read this manual first and understand the safety symbols and messages so you are thoroughly aware of the potential safety hazards.



## CAUTION

Indicates a potentially hazardous situation which, if mishandled, could result in moderate or minor personal injury, and/or property damage.

When the Unit is in Use

- Use the dedicated AC adapter or its equivalent for the unit. Note that the use of other adapter may cause a fire.

# 2 PRODUCT INTRODUCTION

## 2.1 Overview

VX-100RM is an IP remote microphone which has the functions of initiating general broadcast, emergency broadcast and also can trigger the pattern broadcast task by pressing the key.

### (1) Functional configuration through VX-1000 Setting Software

Users can configure the network parameters of IP Remote Microphone, extend the number of units, and customize function keys through the VX-1000 Setting Software to achieve personalized configuration.

### (2) Audio broadcasting

IP Remote Microphone can transmit incoming audio signals of external lines or the microphone through the network to broadcast audio stream data. Each zone can receive and broadcast audio in real-time. The IP Remote Microphone can switch the sound source between the line input and the microphone.

### (3) Working status indicator LED

Each keypad of the IP Remote Microphone is equipped with corresponding indicator LEDs. By identifying the colors and flashing conditions of each indicator, the work of each zone (or key) can be quickly obtained.

### (4) 9 Remote Microphone Extension (RM-110VX) expandable

Each expansion unit has 10 keys, users can add up to 9 pcs which has 100 function keys.

### (5) Controlling task execution

When the function key of IP Remote Microphone is defined as the task key in the VX-1000 Setting Software, pressing the corresponding key can control the corresponding tasks (such as broadcast task, control output task, monitoring task) to start and stop.

## 2.2 Interface Description

### 2.2.1 IP Remote Microphone VX-100RM

[ Front ]

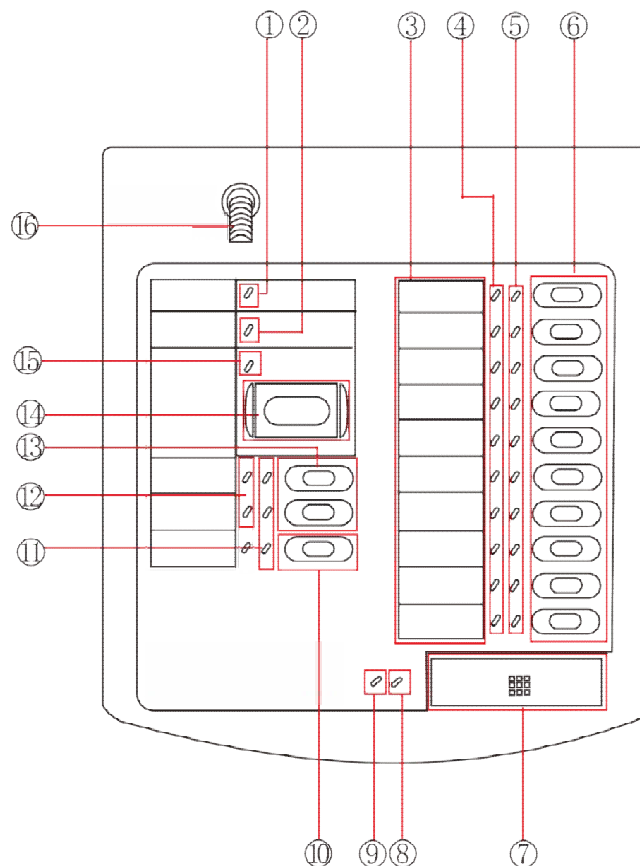

- ① Power LED: A green LED will be always on when it is powered on; No LED lights when no power input
- ② Operation mode LED: No LED lights when under server mode; Orange LED will be always on when under no server mode.
- ③ Name tag area: Please fill in the name or function specified by the corresponding function key on the sign, and insert the signage into the area.
- ④ Status LED: When the function key is defined as zone key, meanwhile when it is under broadcasting status, the corresponding Status LED is always on; In the idle status, no lights; When initiating emergency broadcast, the LED turns to Red.
- ⑤ Zone LEDs:
  - i. When the key is defined as a zone key, pressing the key indicates that the zone represented by the key is selected and the zone LED of the key turns to green; Press again to stop the task and the zone LED is off.
  - ii. When the key is defined as the task key and the binded task is executed, the zone LED of the key turns to green; Press again to stop the task and the zone LED is off.
- ⑥ Function keys: Users can customize the function keys as zone key or task key. (It is configured through "IP Remote Microphone settings" in the VX-1000 Setting Software)
  - i. Zone key: Each key represents a zone, pressing the key means that the zone of the key is selected and the corresponding zone LED turns to green
  - ii. Task key: pressing the key to execute the corresponding task in the VX-1000 Setting Software (playing pattern broadcast, monitor function, etc.). When the task is executed, the corresponding task key's zone LED turns to green; Pressing the key again to stop the task and the corresponding zone LED is off.
- ⑦ Broadcast key: After selecting the zones, then pressing this key to start broadcasting.
- ⑧ Microphone Input Indicator LED: When initiating broadcast, this LED turns to orange. Its brightness will change by the microphone input level and the LED is off when there is no sound.

- ⑨ Broadcast LED: when the IP Remote Microphone is under the broadcast, the indicator LED turns to green; After the broadcast is stopped, the indicator LED is off
- ⑩ Sound source toggle key: Press this key to switch between line input and the microphone input. The default of sound source is the microphone input. Users can press the key to switch to line input. In case that the sound source is line input selected, the corresponding input sound source status LED turns to green.
- ⑪ Function key indicator LED: It indicates the current input sound source, volume + / - key's working status.
- ⑫ Volume status LED: When the volume is adjusted to the maximum, the Volume status LED of the key turns to red. Meanwhile if an user presses the volume reduction key (volume-), the volume status LED of volume increasing key (volume+) is off. When the volume is adjusted to minimum, the corresponding Volume status LED turns to red, meanwhile if the volume is increased, the corresponding Volume status LED is off.
- ⑬ Volume +/- key: When IP Remote Microphone is in broadcasting, users can press these two keys to adjust the volume.
- ⑭ Emergency Broadcast key: Users can press this key to raise microphone priority to emergency level, then selecting zones and initiating emergency broadcast.
- ⑮ Emergency LED: It is always on (in red color), only when pressing the Emergency Broadcast key. Press again the LED turns off.
- ⑯ The Microphone: This is used for real-time broadcasting.

[ Rear ]

[ Side ]

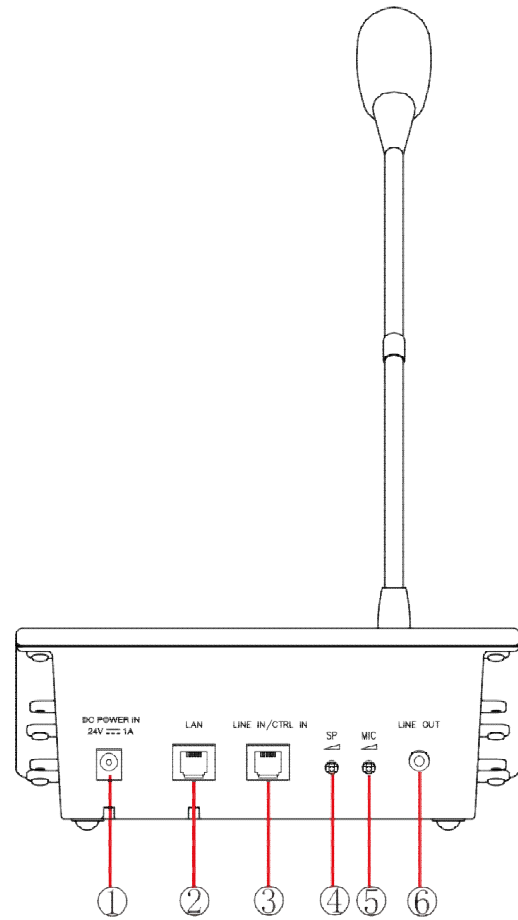
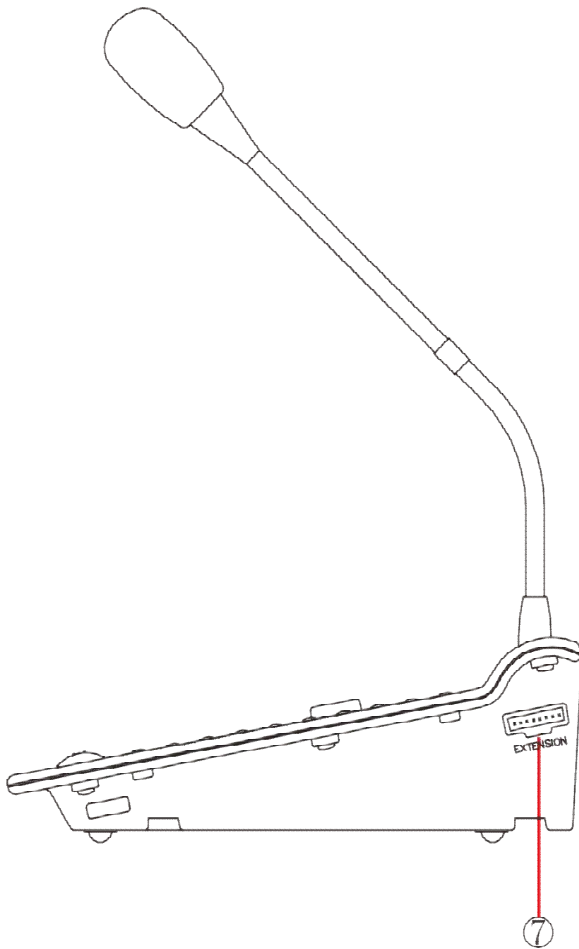

- ① Power input interface: Connecting DC24V/1A power supply AC adapter. (this unit supports PoE power supply. If a network interface has been connected to a POE switching HUB etc., then no need to connect a DC power supply).
- ② Network interface: Connecting to a network device via network cable.
- ③ Control input interface & line input interface.
  - i. Control input interface is unused.
  - ii. Line input interface: Receiving audio signals from other devices.
- ④ SP volume: Adjusting the volume for monitor speaker output.
- ⑤ MIC volume: Adjusting the volume for the microphone input.
- ⑥ Audio output interface: not used.
- ⑦ Extended unit interface: Connecting "Remote Microphone Extension" RM-110VX.

## 2.2.2 Remote Microphone Extension RM-110VX

[ Front ]

[ Side ]

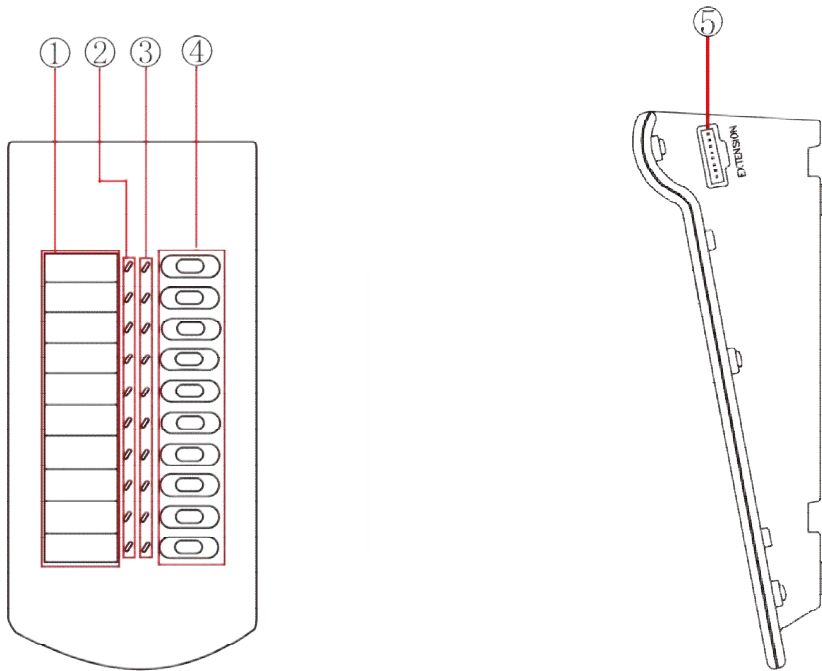

- ① Name tag area
- ② Status LED
- ③ Zone LED
- ④ Function keys
- ⑤ Extension unit interface

For each interface and function definition, please refer to 2.2.1 IP Remote Microphone VX-100RM.

### 3 WIREING

#### 3.1 Wiring Diagram

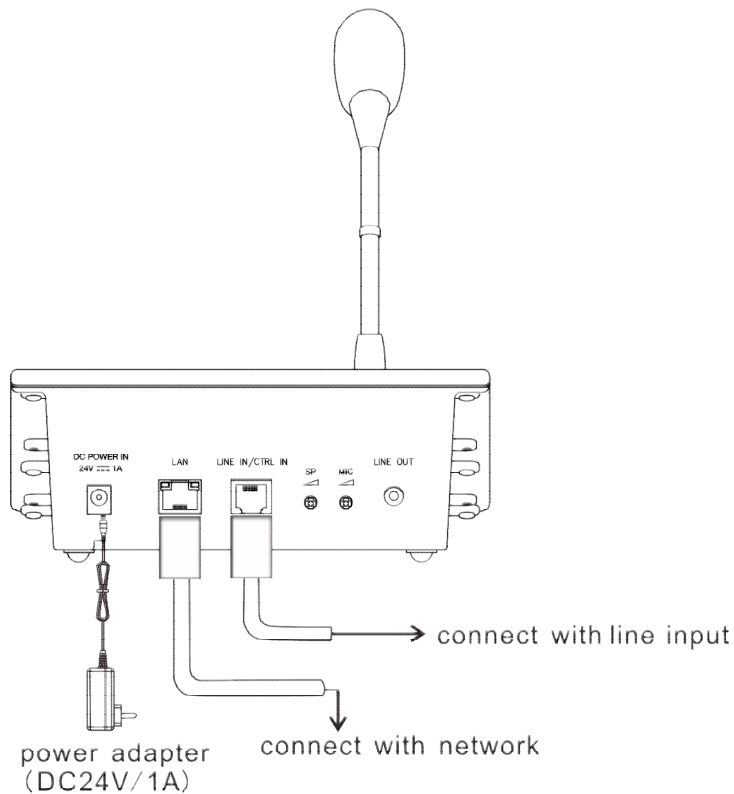

RJ-45 connector's wiring sequence and its meaning:

RJ-45 connector plug NO.

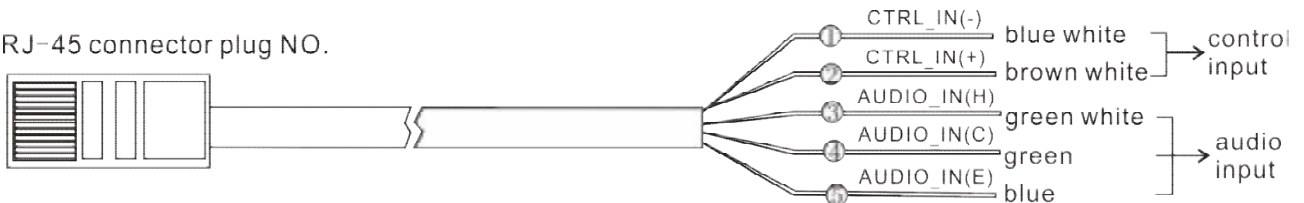

Number	Color	Wire Pair	Pin Assignment	Explanation	Remarks
①	BLUE/WHITE		CTRL_IN (-)	CTRL_IN (-)	CTRL_IN Unused
②	BROWN/WHITE		CTRL_IN (+)	CTRL_IN (+)	
③	GREEN/WHITE		AUDIO_IN(H)	AUDIO_IN (H)	
④	GREEN		AUDIO_IN(C)	AUDIO_IN (C)	
⑤	BLUE		AUDIO_IN(E)	AUDIO_IN (E)	

**Remarks:**

1. Rated Audio Input(Balanced) : 1Vrms ; Maximum Audio Input:2Vrms ; Audio Input Impedance : 10kΩ.
2. Network cable adopts 568B line order, cable order from left to right : Orange White、 Orange、 Green White、 Blue、 Blue White、 Green、 Brown White、 Brown.



## 3.2 Installation Instructions

When the unit adds extra expansion units, users can use extension cable and junction bracket to secure two parts.

### [required accessories]

Required accessories are included in random accessories.

Junction bracket A.....	2
Junction bracket B.....	1
Screw (3 x 8) .....	12

**Step 1.** Let VX-100RM and RM-110VX close to each other.

**Step 2.** Connecting the two units with extension wire.

**Step 3.** Use the 4 screws provided (follow  shown in the picture) and junction bracket B to tie the two unit together.

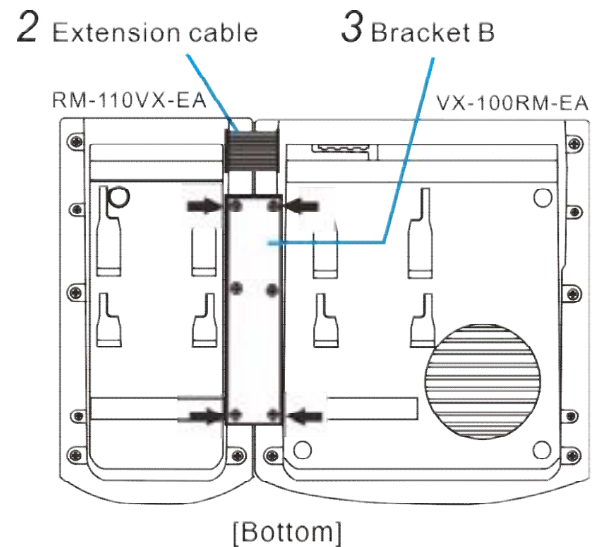

**Step 4.** Using the 8 screws provided (follow  shown in the picture) and two junction bracket A to secure two units.

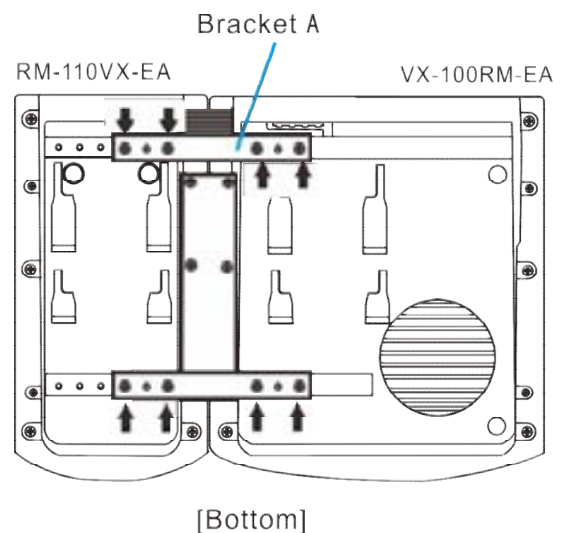

### Remarks:

- The junction bracket A has two spare screw holes. If the specified screw holes are damaged, using them to secure the two units.
- If the connection between the two units is incorrect or loose, please unscrew all fixing screws in bracket and disassemble the two units, then re-secure the two units.

# 4 OPERATION INSTRUCTIONS

## 4.1 VX-1000 Setting Software operating instructions

### 4.1.1 Software Installation

Double-click the "VX-1000 Setting Software" installer and press "Next" to install. After the installation is complete, select "Run as administrator" software.

### 4.1.2 Basic parameter settings

- (1) **New project file** : Click "File"->"New" in the main interface of the software, enter the project name in the pop-up dialog box, and create a new project file. After the new creation is complete, related settings such as system name and screen display can be made on the "Basic Settings" interface.

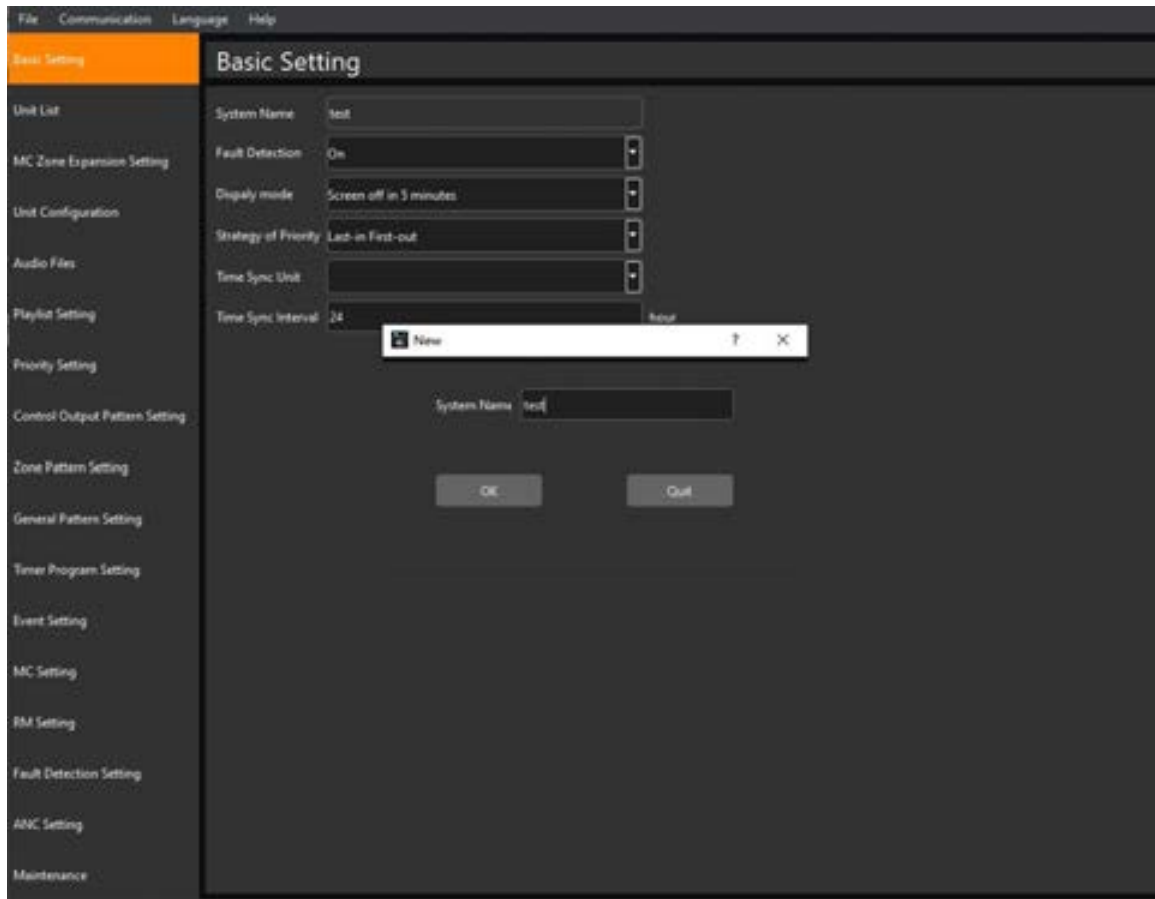

- (2) **Add Unit** : In the "Unit List" interface, add units, set unit's IP and other operations. After the configurations are completed, the system will save configurations automatically.

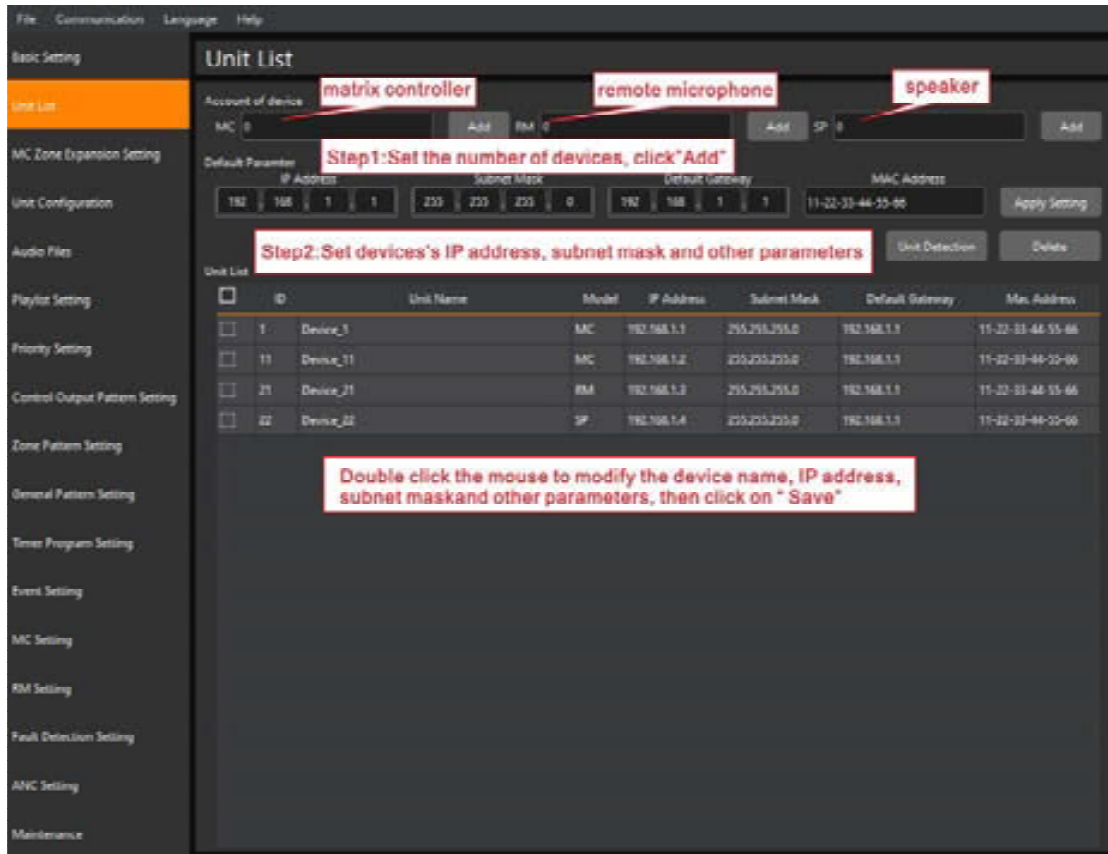

- (3) **Add VX-1010ZE**: Set the number of Zone Expander VX-1010ZE. If the VX-1010ZE is not connected, then you do not need to set this parameter. A maximum of 16 Zone Expander can be added. After the configurations are completed, the system will save configurations automatically.

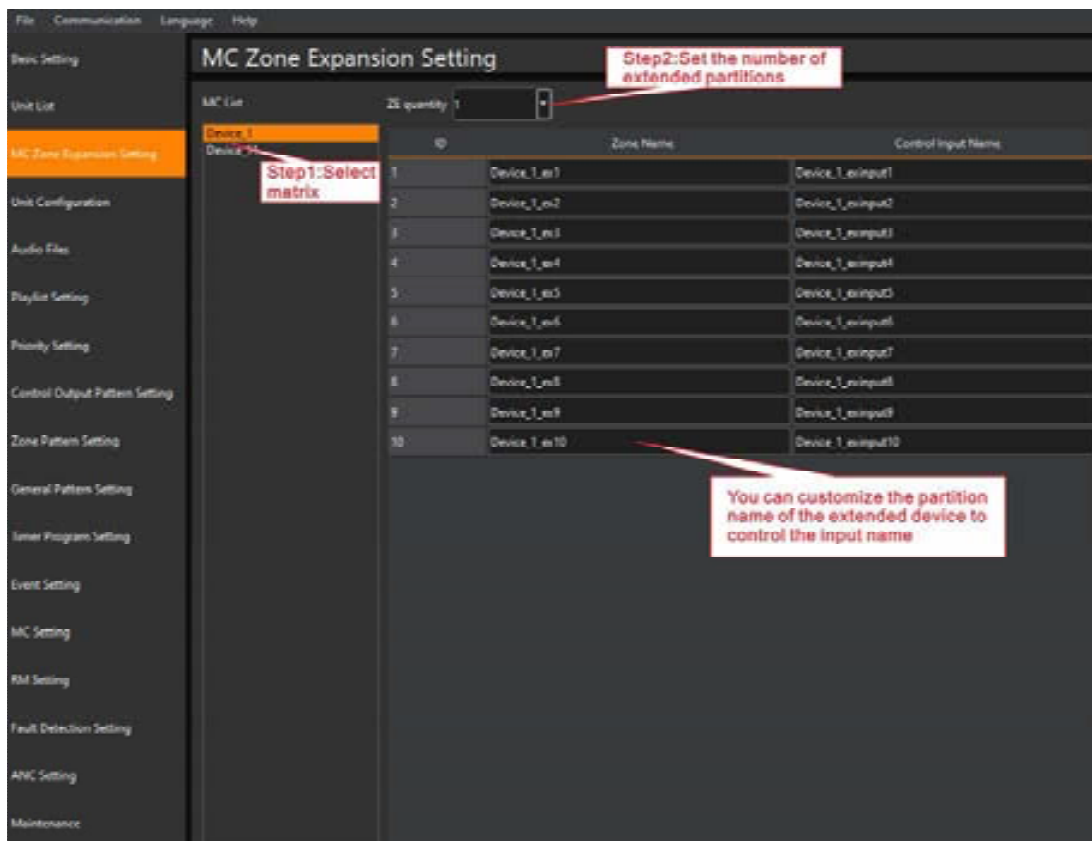

(4) **Unit Configuration** : After units are added, the names of the input and output channels and control input and output channels of each Matrix Controller can be customized in the unit configuration interface. After the configurations are completed, the system will save configurations automatically. The configuration of the Matrix Controller is described as follows:

- i. Select the corresponding Matrix Controller in Unit List. You can customize the input/output channel name, volume, whether to enable the ground detection function, and the name of the control input/output channel for each Matrix Controller. (**Note: Input channels 1-4 respectively correspond to the 4-channel audio source input of the Matrix Controller, and output channels 1-4 respectively correspond to the 4-channel line output of the Matrix Controller. Grounding detection is not enabled when using DA-X power amplifier or such not VX-1000DA units.**)
- ii. If Zone Expander VX-1010ZE are connected, set the channel type in Output Settings. To connect one power amplifier to the Zone Expander, select single channel; to connect two power amplifiers to the Zone Expander, select double channel. A single channel supports only one broadcast output. You can select any channel 1, 2, 3, or 4 as the output channel. Dual channel Supports BGM and two priority broadcasts. You can select 1, 2, or 3, or 4 output channels (1 indicates channels 1 and 2, and 3 indicates channels 3 and 4). BGM broadcasts output from 2 and 4, and priority broadcasts output from 1 and 3.

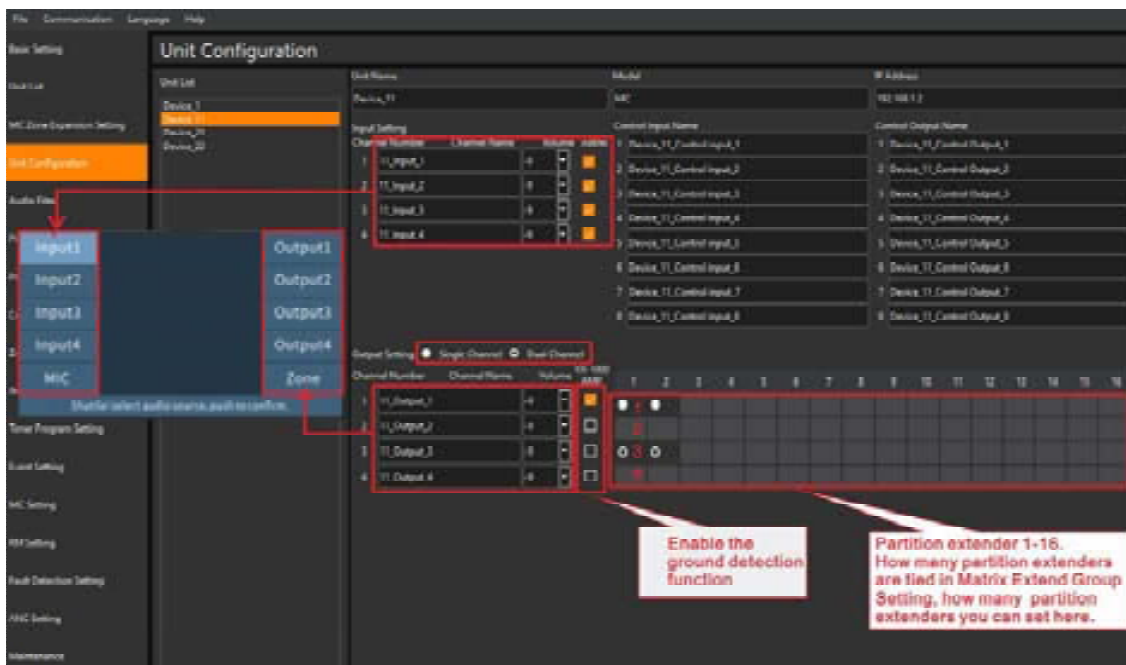

- (5) **Prepare Audio Files** : Click the "Add" button in the "Audio Files" to add audio files (used as a broadcast source). After the configurations are completed, the system will save configurations automatically.



- (6) **Playlist Setting** : Set the broadcast audio file playlist (need to add audio files in the "Audio Files" in advance). After the configurations are completed, the system will save configurations automatically.

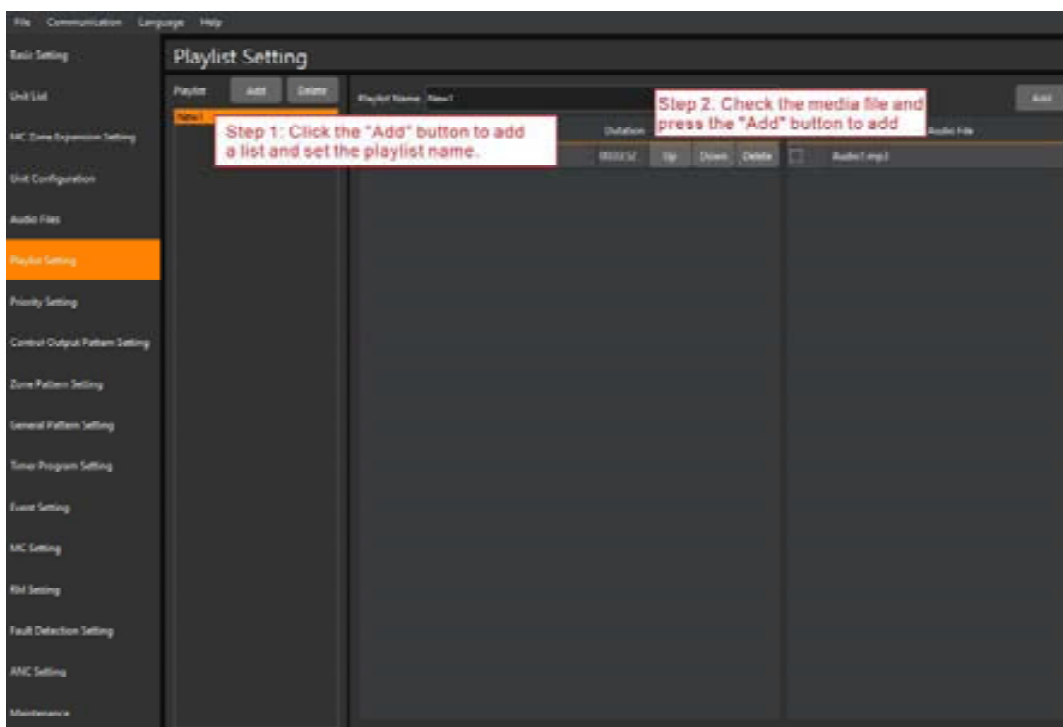

- (7) **Set audio source priority** :Set the audio source type (BGM/General/Emergency) and priority of the unit input channel and playlist. After the configurations are completed, the system will save configurations automatically.

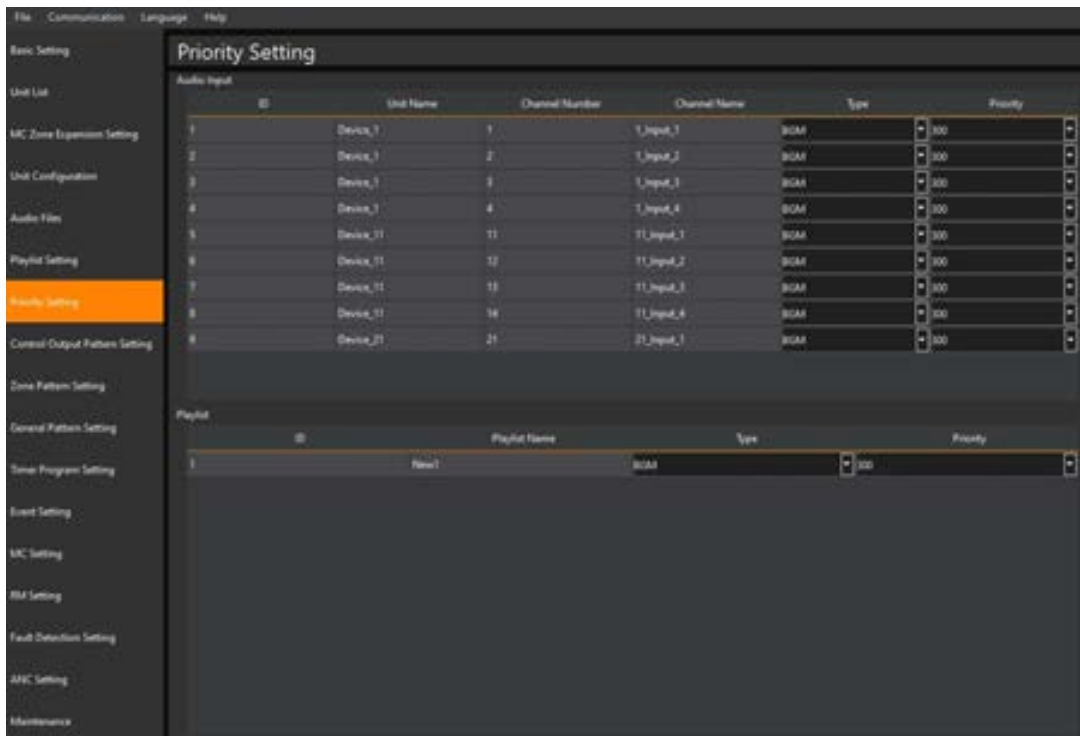

- (8) **Set Control Output Pattern**: On the “Control Output Pattern Setting” interface, multiple control output can be combined to one group.

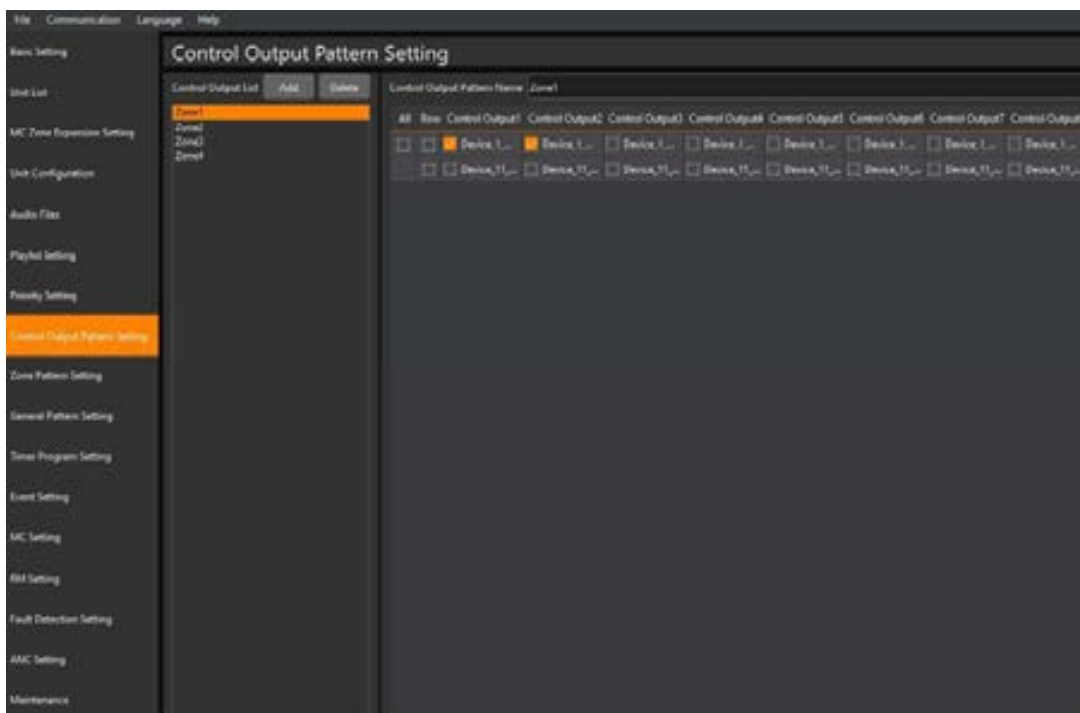

- (9) **Set Zone Pattern** : Enter the “Zone Pattern Setting” interface, create zone patterns which can consist of zones and control outputs. After the configurations are completed, the system will save configurations automatically.

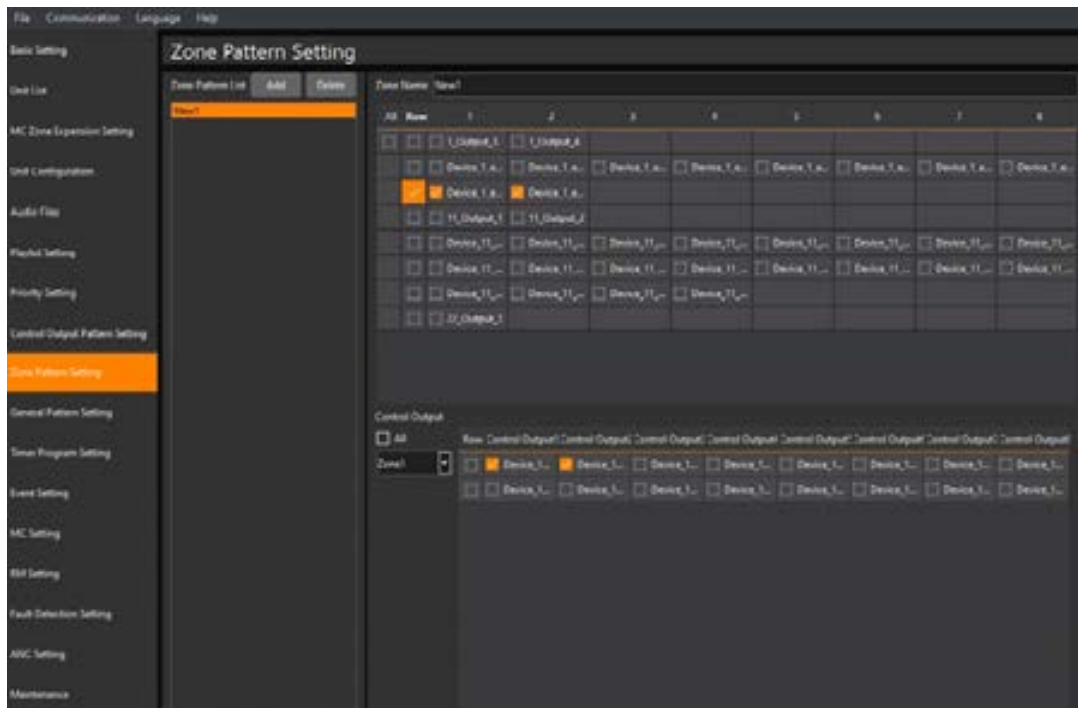

- (10) **Set Broadcast Pattern** : Enter the “General Pattern Setting” interface, create broadcast patterns which consists of audio source, zones and control outputs. After the configurations are completed, the system will save configurations automatically.

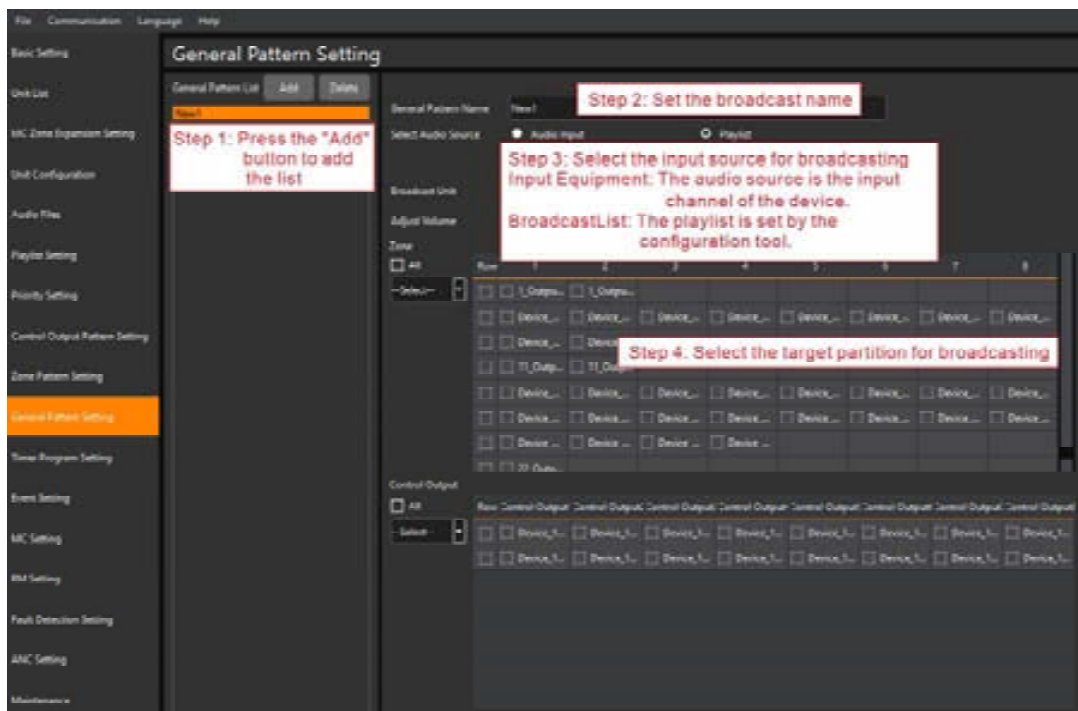

### 4.1.3 Set the timer to start broadcasting

On the "Timer Program Setting" interface, set the Timer Program name, select "General Pattern", set "Timer type", "Start Date", "End Date", etc. When the unit reaches the specified time, it will start the specified broadcast pattern.

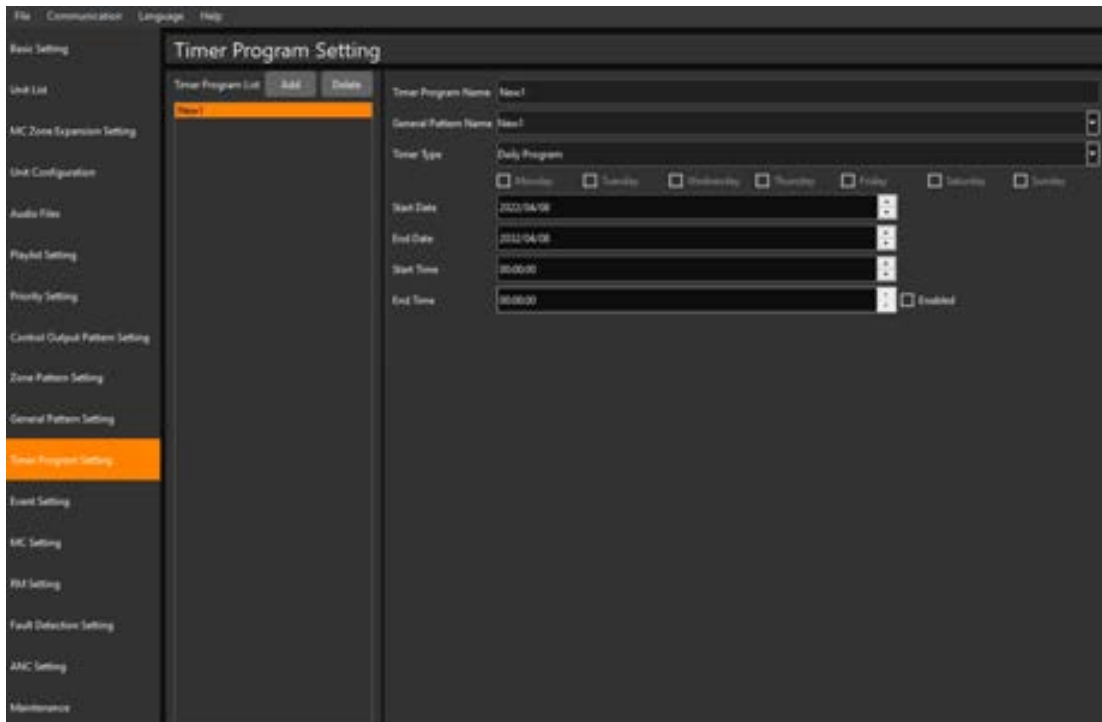

### 4.1.4 Set Event to start broadcasting

On the "Event Settings" interface, set the "Event name", select "General Pattern", and select "Control Input" signal. When the control input of the unit is triggered, the specified general pattern will be activated.

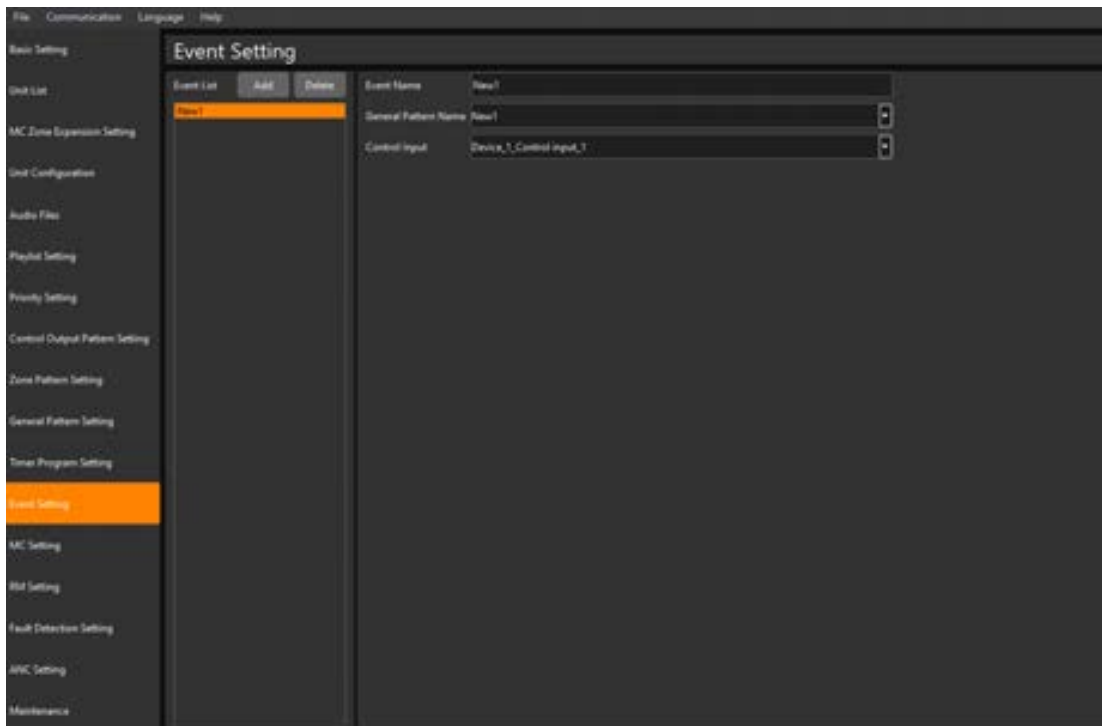



### 4.1.5 Set Preset-Key to start broadcast

On the "MC Settings" interface, you can set the general pattern corresponding to the [Preset 1]-[Preset 3] keys of the Matrix Controller. Press the unit's [Preset 1] - [Preset 3] key to start the specified general pattern.

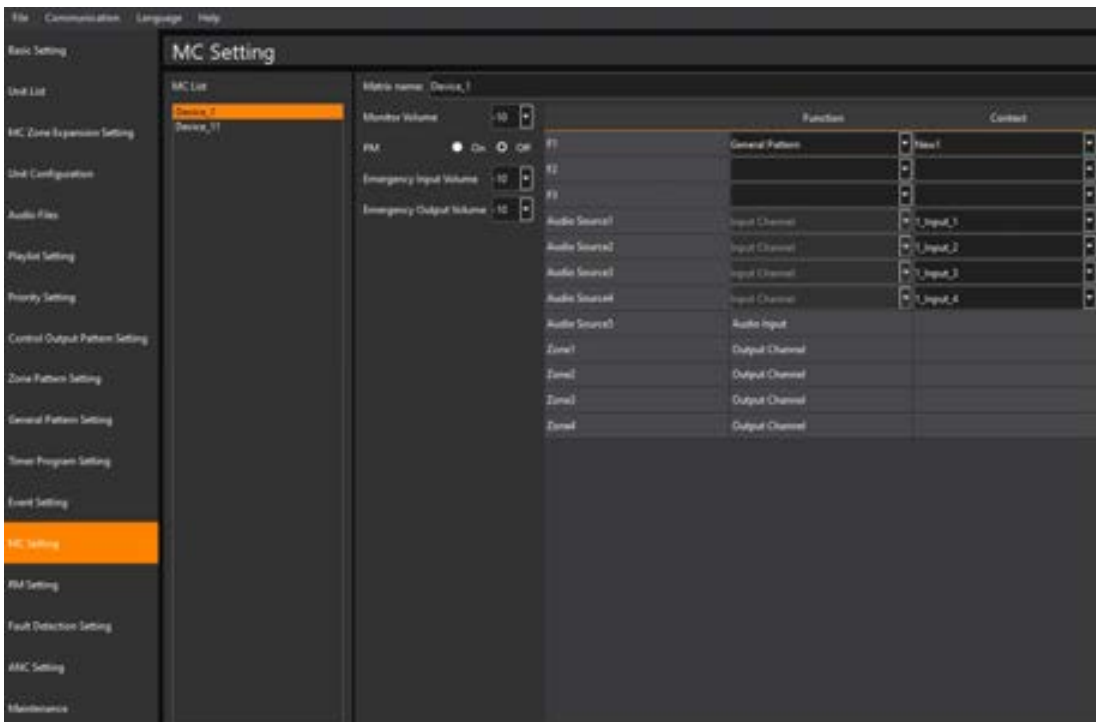

### 4.1.6 Set Remote Microphone function

On the "RM Settings" interface, you can configure the remote microphone.

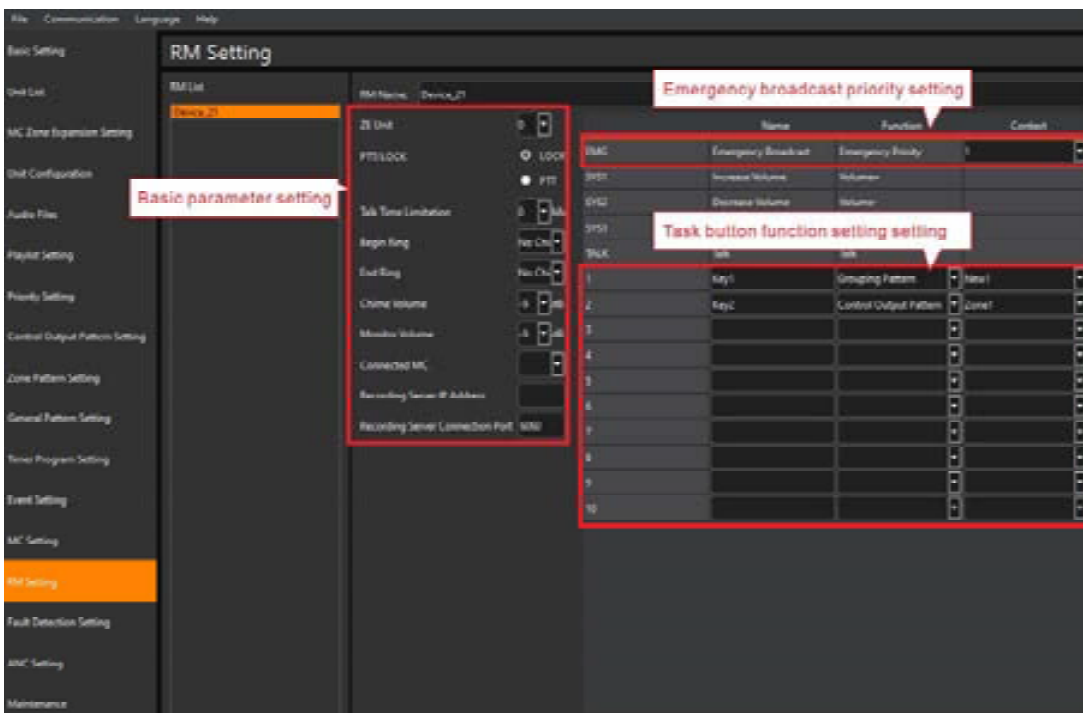

Basic parameter setting	Extension unit setting	Set the number of extension units connected to the remote microphone, and support up to 9 extension units.
	PTT/LOCK	<b>PTT mode:</b> When broadcasting, press the selection key first, and then continue to hold the Broadcast key, then you can initiate a call. Release the Broadcast key to end the broadcast. <b>LOCK mode:</b> When broadcasting, press the selection key first, then press the Broadcast key to initiate a call. Press the Broadcast key again to end the broadcast.
	Talk Time Limitation	Set the duration of the broadcasting, after the time, the unit will automatically end the broadcast. When the time limit is set to 0, the speaking time is not limited, and the broadcasting ends manually.
	Pre-announcement tone settings (Begin Ring/End Ring)	Set the unit to start broadcasting and end broadcast pre-announcement tone, when set to "No chime", there is no pre-announcement tone;
	Pre-announcement tone volume	The volume configuration of the start and end pre-announcement tone.
	Monitor volume	The output volume configuration of the microphone monitor speaker.
	Connected MC	It is required to select one of Matrix Controller for activating playlist.
EMERGENCY Broadcast Key	EMERGENCY Priority	Set the broadcast priority of the EMERGENCY Broadcast key of the remote microphone, the priority range is 1 ~ 128;
Task key function setting	General pattern	Select the General Pattern, the corresponding list shows the preset pattern set on the VX-1000 "General Pattern Setting" interface. After selecting the corresponding general pattern, press the corresponding key to execute the general pattern; press the key again to end the general pattern.
	Grouping pattern	Select the zone. The corresponding list shows the zone list set on the VX-1000 "Zone Pattern Setting" interface. After setting the zone pattern, press the corresponding key and then press the Broadcast key to initiate a microphone broadcast.
	Control output pattern	Select the control output pattern. The corresponding list shows the control output list set on the VX-1000 "Control Output Pattern Setting" interface. After setting the control output pattern, press the corresponding key, the corresponding control output is closed, and press the key again, the corresponding control output is disconnected.
	Monitor Function	Select the monitor function, corresponding to the unit output list displayed in the list. After configuring the monitoring output, press the corresponding key, the microphone monitor speaker plays the audio of the corresponding output, and press the key again to end the monitoring output.
	Failure Detection	Select Failure Detection and the Remote Microphone [Fault Information] screen will display a list of amplifiers configured with the VX-1000. When the microphone detects an amplifier fault, it will indicate accordingly.
	Trigger mode	Select the trigger mode, the function of the corresponding key for the remote microphone is the corresponding Matrix Controller unit selected in the VX-1000 Setting Software (the key trigger task needs to be configured on the SIP server). Pressing the corresponding key will trigger the microphone to initiate a broadcast.

## 4.1.7 Upload configuration

After the parameters are modified and saved, you must click [Communication]-[Upload], check the relevant unit in the pop-up dialog box, and then click the "Upload" button to upload the configured data file to the specified unit to take effect.

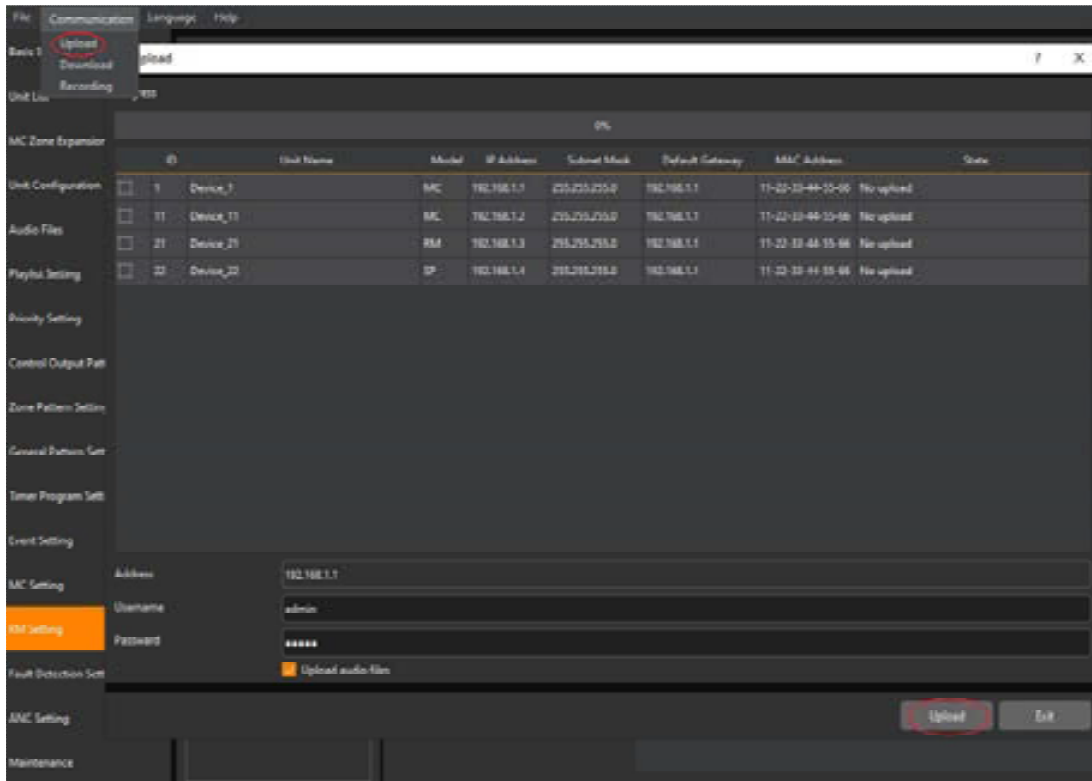

## 4.2 Zone broadcast

**Prerequisites:** Completing relevant configuration, meanwhile IP Remote Microphone function key was set up as “zone pattern”, and upload to the corresponding unit.

### 4.2.1 General zone broadcast

**Step 1.** manually press the zone key to select the zone, and the corresponding key 's zone LED is always on green.

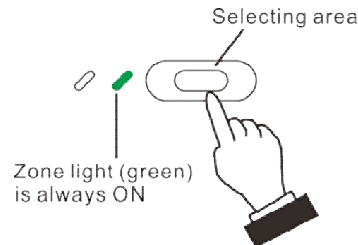

**Step 2.** Press the Broadcast key to start broadcasting. After initiating the broadcast, the status LED of the associated zone is always on orange.

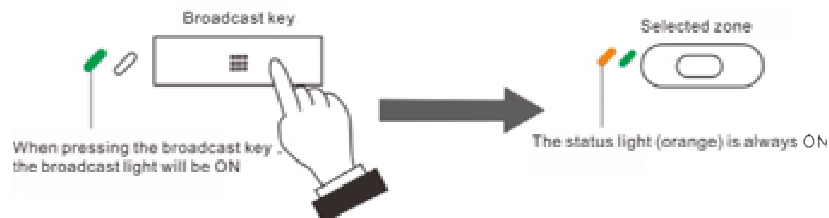

**Step 3.** call the specified zone (microphone input) or play the external sound source (line input). The unit is default as microphone input, then press sound source toggle key to switch to line input, press again to resume it to default.

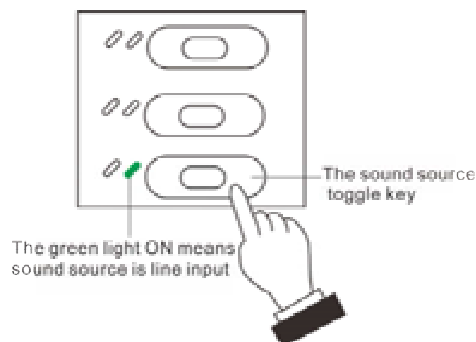

**Step 4.** press the Broadcast key again to end the broadcast, and the Broadcast LED and associated status LED and area LED are all off.

Note: if the unit is set up in PTT mode, when user talking, it is necessary to press the Broadcast key continuously, or releasing the key to end broadcast.

## 4.2.2 Emergency broadcast

**Step 1.** press the Emergency Broadcast key on the microphone, and the Emergency LED is always on red.

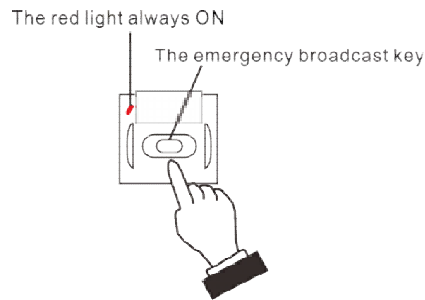

**Step 2.** press the zone key to select the zone, and the zone LED of the corresponding key is always on green.

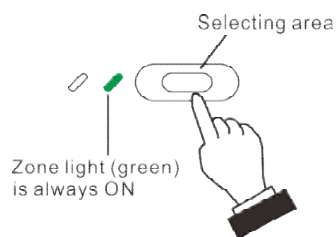

**Step 3.** press the Broadcast key to start broadcasting. After successfully initiating broadcast, the status LED of the associated zone is always on red, and the Broadcast LED is always on green.

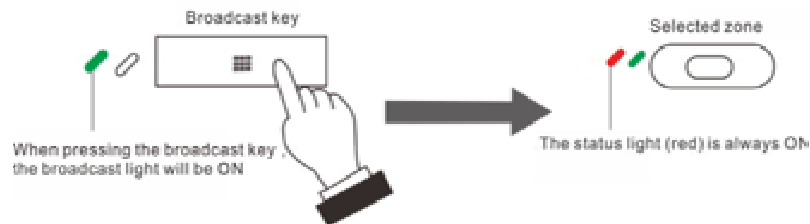

**Step 4.** call the specified area (microphone input) or play the external sound source (line input).

**Step 5.** press the Broadcast key again to end the broadcast, and the Broadcast LED and associated status LED and area LED are all off.

Note: if the unit is set up in PTT mode, when user talking, it is necessary to press the Broadcast key continuously, or releasing the key to end broadcast.

## 4.3 Pattern broadcast

**Prerequisites:** After Completing relevant configuration, meanwhile IP Remote Microphone function key was set up as “broadcast pattern”, then upload to the corresponding unit.

### 4.3.1 General Pattern broadcast

**Step 1.** Press the configured task key, the corresponding zone LED is always on green and the Broadcast LED is always on orange, meanwhile the corresponding zone 's speaker will play the general pattern broadcast.

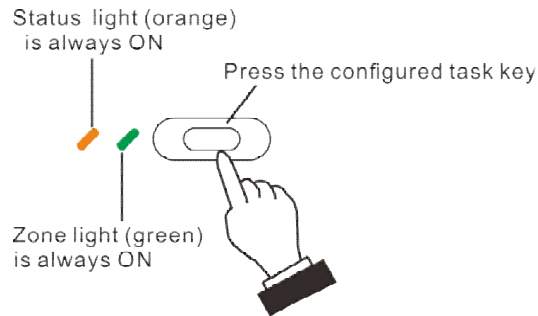

**Step 2.** Press the configured task key again to stop broadcasting. All relevant LEDs will be off.

### 4.3.2 Emergency Pattern broadcast

**Step 1.** press the configured task key, and the corresponding zone LED is always on green and the Broadcast LED is always on red, meanwhile the corresponding zone 's speaker will play the pattern broadcast.

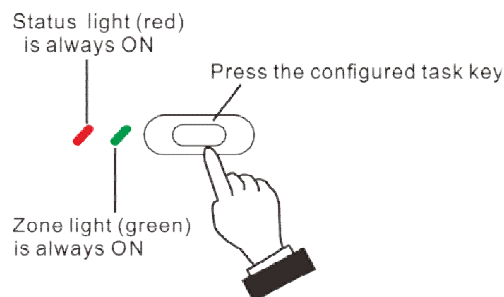

**Step 2.** meanwhile the corresponding zone 's speaker will play the pattern broadcast.

## 4.4 Trigger control output task.

**Prerequisites:** Completing relevant configuration, meanwhile IP Remote Microphone function key was set up as “control output pattern”, then upload to the corresponding unit.

**Step 1.** Press the configured task key, the corresponding zone LED is always on green and the Broadcast LED is always on orange, meanwhile the corresponding control output will be closed to execute specified task.

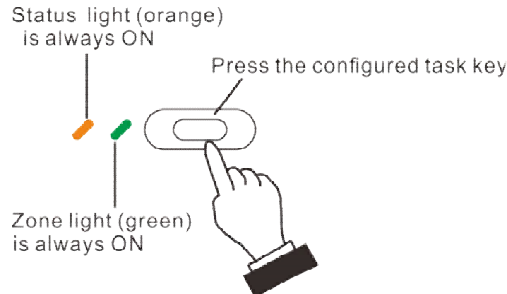

**Step 2.** press the configured task key again to disconnect the control output port. At the same time, all relevant LEDs are off.

## 4.5 Monitoring Function

**Prerequisites:** the unit configuration has been carried out in the VX-1000 Setting Software. The remote microphone key function is configured as "Monitor Function" and upload to the corresponding unit.

**Step 1.** Press the configured task key, the corresponding zone LED is always on green and the Broadcast LED is always on orange, meanwhile the corresponding zone 's speaker will output corresponding output channel's sound.

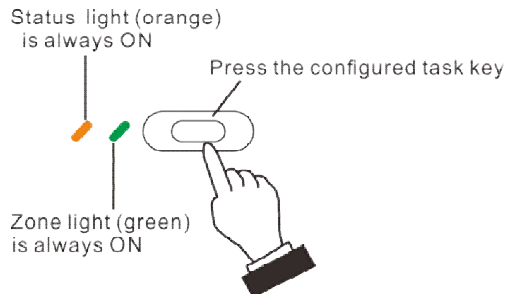

**Step 2.** Press the configured task key again to stop monitoring. All relevant LEDs will be off.

4.6 Dimension (Unit: mm)

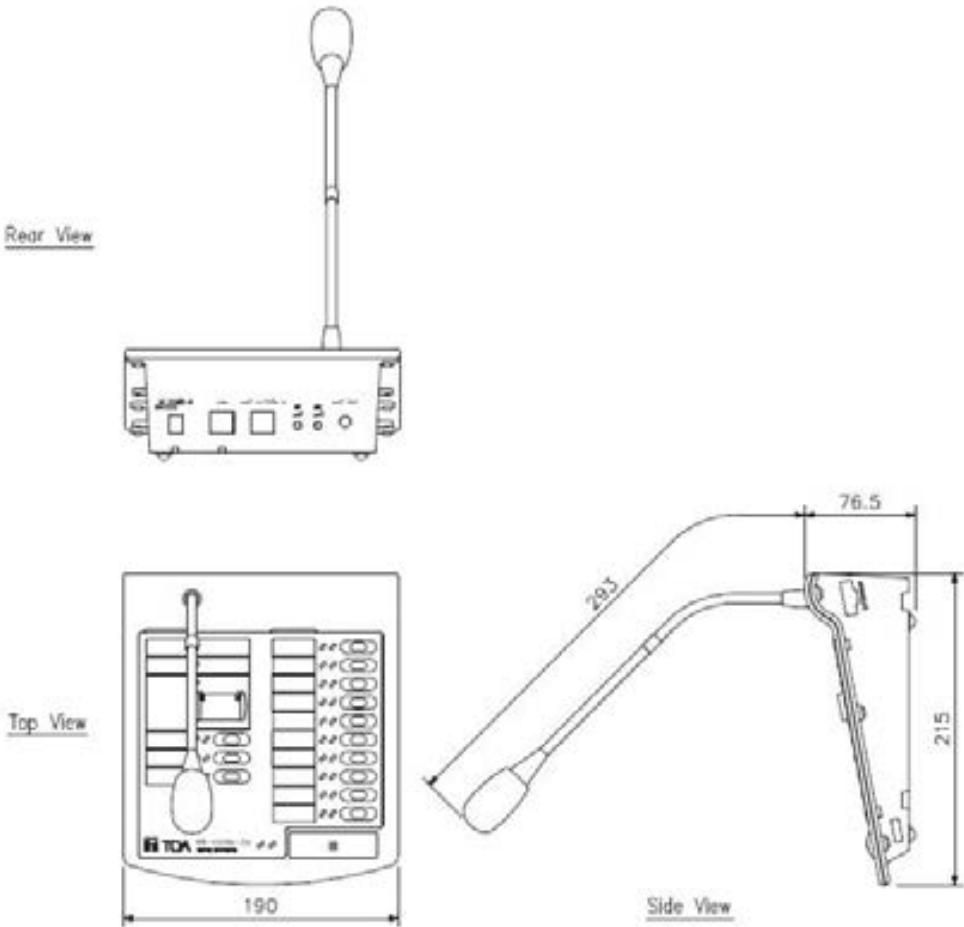



## 5 APPENDIX

### 5.1 Specifications

#### 5.1.1 VX-100RM IP Remote Microphone

Model	VX-100RM
Power Supply	DC24V/1A or PoE (IEEE 802.3at)
Consumption current	Less than 200mA (single VX-100RM) Less than 500mA (when connecting 9 units of RM-110VX)
Audio input	Balance, 1Vrms (Max:2Vrms) the input impedance is10K ohm.
Audio output	Unbalance, 1Vrms, Output impedance 10kΩ
Monitor speaker	1W
Frequency response	20~20,000Hz
Volume control	Microphone volume control, monitor speaker volume control
Number of function keys	10 keys by single unit, up to 100 keys (with 9 * RM-110VX)
Network interface	RJ45 interface, 100BASE-TX, Auto MDI/MID-X
Network protocol	TCP/IP, UDP, HTTP, ARP, RTP, ICMP, IGMP, SIP
Operating Temperature	0°C~+40°C
Operating Humidity	Less than 90%, no condensation.
Finish	ABS resin, black
Dimensions	190 (W) x 76.5 (H) x 215 (D) mm (without gooseneck microphone)
Weight	828 g

#### 5.1.2 RM-110VX Remote Microphone Extention

Model	RM-110VX
Power Supply	(by VX-100RM)
Consumption current	Less than 20mA (by VX-100RM DC power input)
Number of function keys	10
Operating Temperature	0°C~+40°C
Operating Humidity	Less than 90%, no condensation.
Finish	ABS resin, black
Dimensions	110(W) x 76.5 (H) x 215 (D) mm
Weight	343 g
Accessories	Extension cable * 1 Junction bracket A * 2 Junction bracket B * 1 Screw (3 x 8) * 12

Traceability Information for Europe

Manufacturer:

TOA Corporation

7-2-1, Minatojima-Nakamachi, Chuo-ku, Kobe, Hyogo, Japan

Authorized representative:

TOA Electronics Europe GmbH

Suederstrasse 282, 20537 Hamburg, Germany

URL: <https://toa.com.sg/>